

YORKSHIRE

Price list – 1st March 2011

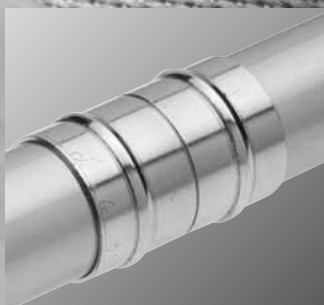

Solder ring solutions

<i>YPS Range</i>	3
<i>YP General Range</i>	3-9
<i>Unions with DZR Nuts</i>	9
<i>Heating Components – Manifolds</i>	9-10
<i>Waste Fittings</i>	10-11
<i>Stopvalves</i>	11
<i>Gate Valves</i>	11-12
<i>Plugcocks</i>	12
<i>Pipe Clips and Brackets</i>	12-13
<i>Pipe Joist Clips</i>	13
<i>Chrome Plated</i>	13-14
<i>Polished Chrome</i>	14-17
<i>Accessories</i>	17
<i>Sundries</i>	18
<i>GHD</i>	18-20
<i>GHD Accessories</i>	20





YPS Range

**YPS1
Straight Coupling**
Copper x copper

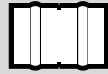

SIZE	BOX QTY	CODE	£ EACH
15mm	100	08010	0.46
22mm	50	08020	1.23

**YPS6
Reducer**
Larger end male copper
for insertion into fitting x
female copper

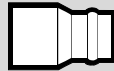

SIZE	BOX QTY	CODE	£ EACH
22 x 15mm	50	08200	2.08

**YPS12
Elbow**
Copper x copper



SIZE	BOX QTY	CODE	£ EACH
15mm	50	08280	0.82
22mm	25	08290	2.17

**YPS12S
Street Elbow**
Female copper x male copper
for insertion into fitting

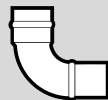

SIZE	BOX QTY	CODE	£ EACH
15mm	10	08318	1.66

**YPS24
Equal Tee**
All ends for copper



SIZE	BOX QTY	CODE	£ EACH
15mm	50	08450	1.58
22mm	20	08460	5.02

**YPS25
Tee, reduced branch**
All ends for copper



SIZE	BOX QTY	CODE	£ EACH
22 x 22 x 15mm	20	08490	3.99

**YPS62
Tap Connector**
Copper x BSP union nut
Spigot and washer joint

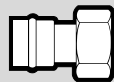

SIZE	BOX QTY	CODE	£ EACH
15mm x 1/2"	50	08700	4.06

YP General Range

**YP1
Straight Coupling**
Copper x copper

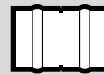

SIZE	BOX QTY	CODE	£ EACH
6mm	10	08000	2.61
8mm	10	08001	2.68
10mm	10	08003	1.35
12mm	10	08005	1.23
15mm	100	08010	YPS
22mm	50	08020	YPS
28mm	25	08030	2.86
35mm	10	08032	9.67
42mm	2	08034	16.14
54mm	2	08035	29.76
67mm	1	08036	88.37

**YP1FD
Flanged Connector**
Copper x BS flange
Flange in accordance with
BS 10, Table D
For bi-metal flange,
refer to Endbraze section



SIZE	BOX QTY	CODE	£ EACH
28mm (4 hole)	1	08075	111.80
35mm (4 hole)	1	08076	146.87
42mm (4 hole)	1	08077	175.55
54mm (4 hole)	1	08078	265.41

**YP1FM
Metric Flanged Connector**
Copper x BS flange
Flange in accordance
with BS 4504
For bi-metal flanges refer
to Endbraze section



SIZE	BOX QTY	CODE	£ EACH
28mm (4 hole)	1	08082	111.80
35mm (4 hole)	1	08083	146.87
42mm (4 hole)	1	08084	175.55
54mm (4 hole)	1	08085	265.41
67mm (8 hole)	1	08086	327.67

**YP1IM Slip
Adaptor Coupling**
Imperial x metric
Copper x copper
To connect imperial
tube to metric tube



SIZE	BOX QTY	CODE	£ EACH
1/2" x 15mm	10	08040	6.72
3/4" x 22mm	10	08050	5.90
1" x 28mm	10	08052	11.61
1 1/4" x 35mm	10	08054	20.14
1 1/2" x 42mm	1	08055	25.61

**YP1R
Reducing Coupling**
Copper x copper

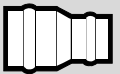

SIZE	BOX QTY	CODE	£ EACH
8 x 6mm	10	08056	9.47
10 x 8mm	10	08057	8.31
15 x 8mm	10	08058	5.90
15 x 10mm	10	08059	5.70
15 x 12mm	10	08060	4.36
22 x 8mm	10	08061	8.35
22 x 10mm	10	08062	8.35
22 x 15mm	10	08063	5.61
28 x 15mm	10	08065	12.80
28 x 22mm	10	08066	7.83
35 x 22mm	10	08067	18.81
35 x 28mm	10	08068	19.15
42 x 28mm	1	08069	32.04
42 x 35mm	1	08070	28.10
54 x 35mm	1	08071	49.30
54 x 42mm	1	08072	53.82

**YP1 Slip
Straight Coupling,
Slip Pattern**
Copper x copper



SIZE	BOX QTY	CODE	£ EACH
15mm	10	08037	3.11
22mm	10	08038	6.51
28mm	10	08039	9.58

**YP2
Adaptor Coupling**
Straight female connector
Copper x BSP parallel
female thread



SIZE	BOX QTY	CODE	£ EACH
8mm x 1/4"	5	08087	9.98
15mm x 1/2"	10	08090	7.05
22mm x 3/4"	10	08092	10.20
28mm x 1"	5	08093	19.28
35mm x 1 1/4"	1	08094	34.58
42mm x 1 1/2"	1	08095	44.88
54mm x 2"	1	08096	71.16

**YP2LC
Female Reducing Connector**
Straight female connector
As YP2 but with reduced
BSP female end



SIZE	BOX QTY	CODE	£ EACH
12mm x 1/4"	10	08100	10.20
15mm x 1/4"	10	08101	12.52
15mm x 3/8"	10	08102	14.03
22mm x 1/2"	10	08103	16.22

**YP2LI
Female Reducing Connector**
Straight female connector
As YP2 but with reduced
copper end



SIZE	BOX QTY	CODE	£ EACH
1/4" x 15mm	10	08106	17.52

YP General Range (contd)

**YP3
Straight Male Connector**
Copper x BSP taper male thread



SIZE	BOX QTY	CODE	£ EACH
6mm x 1/8"	10	08110	10.44
8mm x 1/4"	10	08111	6.72
12mm x 3/8"	5	08113	10.85
15mm x 1/2"	10	08114	5.99
22mm x 3/4"	10	08116	10.70
28mm x 1"	10	08118	17.30
35mm x 1 1/4"	1	08119	31.51
42mm x 1 1/2"	1	08120	40.58
54mm x 2"	1	08121	61.62
67mm x 2 1/2"	1	08123	98.41
76mm x 3"	1	51033	239.21

**YP3LC
Male Reducing Connector**
As YP3 but with reduced BSP taper male end



SIZE	BOX QTY	CODE	£ EACH
15mm x 1/4"	10	08129	8.20
15mm x 3/8"	10	08132	11.36
22mm x 1/2"	5	08133	16.79
28mm x 3/4"	5	08134	26.46

**YP3LI
Male Reducing Connector**
As YP3 but with reduced copper end



SIZE	BOX QTY	CODE	£ EACH
1/2" x 10mm	5	08141	13.14
1/2" x 12mm	5	08142	10.85
3/4" x 15mm	10	08143	15.62
1" x 22mm	5	08144	23.84

**YP5
Tank Connector**
Copper x BSP parallel male thread with backnut



SIZE	BOX QTY	CODE	£ EACH
15mm x 1/2"	10	08160	14.99
22mm x 3/4"	5	08161	22.83
28mm x 1"	5	08162	30.01
35mm x 1 1/4"	1	08163	39.94
42mm x 1 1/2"	1	08164	52.36
54mm x 2"	1	08165	80.00

**YP5DN
Tank Connector**
Copper x BSP parallel male thread with two backnuts



SIZE	BOX QTY	CODE	£ EACH
15mm x 3/4"	5	08170	30.33

**YP5FC
Tank Connector**
Copper x BSP parallel male thread with backnut

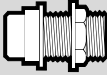

SIZE	BOX QTY	CODE	£ EACH
15mm x 1/2"	5	08180	19.41
22mm x 3/4"	5	08181	27.63
28mm x 1"	1	08182	34.16

**YP6
Reducer**
Larger end male copper for insertion into fitting x female copper



SIZE	BOX QTY	CODE	£ EACH
8 x 6mm	10	08190	7.53
10 x 8mm	10	08191	5.80
12 x 6mm	10	08192	12.73
12 x 8mm	10	08193	4.87
15 x 8mm	10	08194	4.78
15 x 10mm	10	08196	1.91
15 x 12mm	10	08198	3.70
22 x 12mm	10	08199	8.63
22 x 15mm	50	08200	YPS
28 x 15mm	10	08202	6.31
28 x 22mm	10	08204	4.84
35 x 15mm	10	08206	19.60
35 x 22mm	10	08207	18.61
35 x 28mm	10	08208	13.82
42 x 15mm	1	08209	30.09
42 x 22mm	1	08210	33.59
42 x 28mm	1	08211	31.64
42 x 35mm	1	08212	26.00
54 x 15mm	1	08213	66.40
54 x 22mm	1	08214	65.08
54 x 28mm	1	08215	57.16
54 x 35mm	1	08216	54.53
54 x 42mm	1	08217	47.03
67 x 28mm	1	08218	63.94
67 x 35mm	1	08219	63.94
67 x 42mm	1	08220	63.94
67 x 54mm	1	08221	63.94

**YP7
Female Adaptor**
Male copper for insertion into fitting x BSP parallel female thread
There is no solder ring in this fitting



SIZE	BOX QTY	CODE	£ EACH
15mm x 1/2"	10	08223	12.14
22mm x 3/4"	10	08224	18.51
28mm x 1"	10	08225	26.05
35mm x 1 1/4"	1	08226	48.91
42mm x 1 1/2"	1	08227	61.61
54mm x 2"	1	08228	74.15

**YP8
Male Adaptor**
Male copper for insertion into fitting x BSP taper male thread
There is no solder ring in this fitting

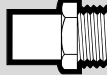

SIZE	BOX QTY	CODE	£ EACH
15mm x 1/2"	10	08230	12.39
22mm x 3/4"	10	08231	15.82
28mm x 1"	5	08232	26.45
35mm x 1 1/4"	1	08233	39.95
42mm x 1 1/2"	1	08234	55.22
54mm x 2"	1	08235	74.15

**YP9
Imperial female copper x metric male copper**
For making the adaptation from imperial size tube to metric

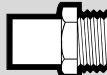

SIZE	BOX QTY	CODE	£ EACH
1/2" x 15mm	10	08238	5.90
3/4" x 22mm	10	08239	6.51
1" x 28mm	5	08240	9.23
1 1/4" x 35mm	1	08241	11.17
1 1/2" x 42mm	1	08242	14.74
2" x 54mm	1	08243	34.80

**YP9B
Non-standard Adaptor**
Adapts imperial tube of older 17G standard to metric fittings

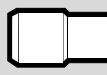

SIZE	BOX QTY	CODE	£ EACH
1/2" 17G x 15mm	10	08245	6.81

**YP99
Adaptor**
Metric/imperial female copper x male copper
To adapt metric tube to imperial fittings

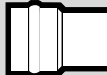

SIZE	BOX QTY	CODE	£ EACH
15mm x 1/2"	5	08920	3.81
22mm x 3/4"	5	08921	5.80
28mm x 1"	5	08922	7.78
35mm x 1 1/4"	1	08923	15.29
42mm x 1 1/2"	1	08924	21.65

**YP11
Union Coupling**
Copper x copper
Cone joint to BS 1010



SIZE	BOX QTY	CODE	£ EACH
8mm	5	08250	20.14
15mm	10	08251	16.77
22mm	5	08252	26.85
28mm	1	08253	39.12
35mm	1	08254	53.25
42mm	1	08255	77.81
54mm	1	08256	148.10
67mm	1	08257	250.78

YP General Range (contd)

YP12 Elbow
Copper x copper



SIZE	BOX QTY	CODE	£ EACH
6mm	10	08265	8.58
8mm	10	08266	5.67
10mm	10	08268	2.29
12mm	10	08270	4.02
15mm	50	08280	YPS
22mm	25	08290	YPS
28mm	10	08300	4.58
35mm	5	08302	20.69
42mm	2	08304	34.19
54mm	2	08306	70.61
67mm	1	08308	183.30

YP12R Reducing Elbow
As YP12 but with one end reduced



SIZE	BOX QTY	CODE	£ EACH
22 x 15mm	10	08310	15.79
28 x 22mm	10	08311	22.37

YP12S Street Elbow
Female copper x male copper for insertion into fitting



SIZE	BOX QTY	CODE	£ EACH
8mm	10	08315	7.74
10mm	10	08316	6.75
15mm	10	08318	YPS
22mm	25	08320	5.13
28mm	10	08322	14.99
35mm	1	08324	34.87
42mm	1	08325	49.08

YP13 Male Elbow
Copper x BSP taper male thread



SIZE	BOX QTY	CODE	£ EACH
15mm x 1/2"	10	08333	12.01
22mm x 3/4"	5	08334	17.04
28mm x 1"	5	08335	25.63
35mm x 1 1/4"	1	08336	37.58
42mm x 1 1/2"	1	08337	44.69
54mm x 2"	1	08338	79.05

YP13LC Reducing Male Elbow
As YP13 but with reduced taper male end



SIZE	BOX QTY	CODE	£ EACH
15mm x 1/2"	5	08341	19.46

YP14 Female Elbow
Copper x BSP parallel female thread



SIZE	BOX QTY	CODE	£ EACH
12mm x 3/8"	5	08350	15.39
15mm x 1/2"	10	08351	10.35
22mm x 3/4"	10	08353	14.99
28mm x 1"	1	08354	25.94
35mm x 1 1/4"	1	08355	41.66

YP14LC Reducing Female Elbow
As YP14 but with reduced female end



SIZE	BOX QTY	CODE	£ EACH
15mm x 1/2"	10	08361	16.55
22mm x 1/2"	10	08362	17.34

YP15 Backplate Elbow
Copper x BSP parallel female thread
Triangular backplate three hole fixing



SIZE	BOX QTY	CODE	£ EACH
15mm x 1/2"	10	08365	12.58
22mm x 3/4"	5	08367	27.02

YP15LN Backplate Elbow
As YP15 but with extended nose and circular backplate



SIZE	BOX QTY	CODE	£ EACH
15mm x 1/2"	5	08377	26.68

YP17 Flange Bend
Copper x BSP parallel male thread

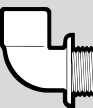

SIZE	BOX QTY	CODE	£ EACH
15mm x 1/2"	5	08380	27.33
15mm x 3/4"	5	08381	28.22
22mm x 3/4"	5	08382	31.06

YP17FC Overflow Bend
Flanged as YP17 but with 38mm (1 1/2") length of thread and backnut
For connection to galvanised tanks use YP17 and backnut 456



SIZE	BOX QTY	CODE	£ EACH
22mm x 3/4"	1	08386	38.07

YP18 Slow Bend
Copper x copper



SIZE	BOX QTY	CODE	£ EACH
15mm	10	08390	2.04
22mm	10	08391	4.00
28mm	5	08392	7.74

YP20 Return Bend
Copper x copper



SIZE	BOX QTY	CODE	£ EACH
15mm	5	08400	18.85
22mm	1	08401	37.03
28mm	1	08402	47.33

YP21 Obtuse Elbow
Copper x copper



SIZE	BOX QTY	CODE	£ EACH
15mm	10	08410	2.41
22mm	10	08412	5.03
28mm	10	08414	9.67
35mm	2	08416	31.22
42mm	1	08417	55.59
54mm	1	08418	100.54
67mm	1	08419	182.42

YP22 Partial Crossover
Female copper x male copper for insertion into fitting



SIZE	BOX QTY	CODE	£ EACH
15mm	5	08420	11.44
22mm	5	08422	24.22

YP23 Full Crossover
Copper x copper



SIZE	BOX QTY	CODE	£ EACH
15mm	5	08430	13.59
22mm	5	08432	27.85

YP24 Equal Tee
All ends for copper



SIZE	BOX QTY	CODE	£ EACH
6mm	10	08440	7.42
8mm	10	08441	9.09
10mm	10	08443	5.26
12mm	10	08445	3.62
15mm	50	08450	YPS
22mm	20	08460	YPS
28mm	10	08462	12.73
35mm	1	08464	33.70
42mm	1	08466	54.05
54mm	1	08467	108.98
67mm	1	08468	237.32

YP General Range (contd)

YP24IM
Adaptor Tee, slip pattern
 All ends for copper,
 imperial to metric branch

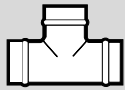

SIZE	BOX QTY	CODE	£ EACH
1/2" x 1/2" x 15mm	5	08470	9.34
3/4" x 3/4" x 22mm	5	08471	15.79

YP24 Slip
Equal Tee, slip pattern
 All ends for copper



SIZE	BOX QTY	CODE	£ EACH
15mm	5	08475	7.74
22mm	5	08476	18.52

YP25
Tee, reduced branch
 All ends for copper

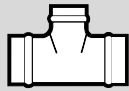

SIZE	BOX QTY	CODE	£ EACH
15 x 15 x 8mm	5	08480	22.73
15 x 15 x 10mm	5	08481	13.72
15 x 15 x 12mm	5	08482	7.04
22 x 22 x 8mm	5	08483	18.58
22 x 22 x 10mm	5	08484	19.20
22 x 22 x 12mm	5	08485	16.59
22 x 22 x 15mm	20	08490	YPS
28 x 28 x 15mm	10	08492	17.66
28 x 28 x 22mm	10	08494	18.81
35 x 35 x 15mm	1	08496	47.49
35 x 35 x 22mm	1	08497	36.75
35 x 35 x 28mm	1	08498	45.06
42 x 42 x 15mm	1	08499	97.75
42 x 42 x 22mm	1	08500	78.96
42 x 42 x 28mm	1	08501	89.60
42 x 42 x 35mm	1	08502	102.01
54 x 54 x 15mm	1	08503	165.11
54 x 54 x 22mm	1	08504	156.36
54 x 54 x 28mm	1	08505	157.04
54 x 54 x 35mm	1	08506	163.78
54 x 54 x 42mm	1	08507	171.41
67 x 67 x 28mm	1	08508	190.56

YP26
Tee, one end reduced
 All ends for copper

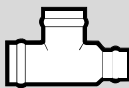

SIZE	BOX QTY	CODE	£ EACH
22 x 15 x 22mm	20	08510	8.31
28 x 15 x 28mm	10	08512	28.13
28 x 22 x 28mm	10	08514	25.73
35 x 15 x 35mm	1	08516	49.76
35 x 22 x 35mm	1	08517	47.24
35 x 28 x 35mm	1	08518	55.81
42 x 28 x 42mm	1	08519	100.75
42 x 35 x 42mm	1	08520	92.17
54 x 42 x 54mm	1	08521	166.70
67 x 54 x 67mm	1	08522	195.91

YP27
Tee, one end and branch reduced
 All ends for copper



SIZE	BOX QTY	CODE	£ EACH
22 x 15 x 15mm	20	08530	7.14
28 x 15 x 15mm	10	08532	31.82
28 x 15 x 22mm	10	08534	36.94
28 x 22 x 15mm	10	08536	25.90
28 x 22 x 22mm	10	08538	23.51
35 x 22 x 22mm	1	08539	71.83
35 x 28 x 15mm	1	08540	57.42
35 x 28 x 22mm	1	08541	49.66
35 x 28 x 28mm	1	08542	43.69
42 x 28 x 28mm	1	08543	91.59
42 x 35 x 28mm	1	08544	68.68
42 x 35 x 35mm	1	08545	96.51
54 x 42 x 42mm	1	08546	144.69

YP28
Tee, both ends reduced
 All ends for copper



SIZE	BOX QTY	CODE	£ EACH
8 x 8 x 15mm	10	08550	21.22
15 x 15 x 22mm	10	08551	10.71
15 x 15 x 28mm	10	08553	27.98
22 x 22 x 28mm	10	08555	25.33
22 x 22 x 35mm	1	08557	39.96
28 x 28 x 35mm	1	08558	50.34
35 x 35 x 42mm	1	08559	70.44
42 x 42 x 54mm	1	08560	112.36

YP29
Female Tee
 Copper end and branch x
 BSP parallel female end

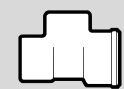

SIZE	BOX QTY	CODE	£ EACH
15 x 1/2" x 15mm	10	08570	9.88
22 x 3/4" x 22mm	5	08572	28.70
28 x 1" x 28mm	1	08574	37.16

YP29R
Female Tee
 As YP29 but with
 reduced female BSP end



SIZE	BOX QTY	CODE	£ EACH
22 x 1/2" x 22mm	5	08575	16.79
28 x 1/2" x 28mm	5	08576	30.99
35 x 1/2" x 35mm	1	08578	58.26

YP30
Female Tee
 Copper ends x BSP
 parallel female branch



SIZE	BOX QTY	CODE	£ EACH
15 x 15mm x 1/2"	10	08585	7.73
22 x 22mm x 3/4"	5	08587	20.36
28 x 28mm x 1"	1	08589	35.68

YP30BP
Backplate Tee
 Copper ends x BSP
 parallel female branch
 with circular backplate



SIZE	BOX QTY	CODE	£ EACH
15 x 15mm x 1/2"	5	08600	29.75

YP30R
Female Tee
 As YP30 but with reduced
 female BSP branch



SIZE	BOX QTY	CODE	£ EACH
15 x 15mm x 1/4"	5	08590	15.70
22 x 22mm x 1/2"	10	08591	10.93
28 x 28mm x 1/2"	5	08592	33.08
28 x 28mm x 3/4"	5	08593	37.69
35 x 35mm x 1/2"	1	08594	56.81
35 x 35mm x 3/4"	1	08595	56.42
42 x 42mm x 1/2"	1	08596	67.79

YP33
Heater Tee
 Parallel male thread x
 parallel female thread
 x branch



SIZE	BOX QTY	CODE	£ EACH
1/2" x 1/2" x 15mm	5	08605	26.76

YP35
Air Vent Tee
 Composed of YP37 sweep tee
 and air-release valve RV35
 Supplied with Dowty seal
 which should be removed
 before soldering
 This tee gives a round full
 bore flow



SIZE	BOX QTY	CODE	£ EACH
15mm	5	08615	23.26

RV35
Air Release Valve
 Male copper end
 suitable for use in any
 capillary socket



SIZE	BOX QTY	CODE	£ EACH
15mm	10	08620	7.65

YP36
Corner Tee
 All ends for copper



SIZE	BOX QTY	CODE	£ EACH
15mm	1	08625	26.85
22mm	1	08626	34.52

YP General Range (contd)

YP37
Sweep Tee, 90°
All ends for copper

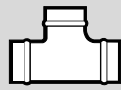

SIZE	BOX QTY	CODE	£ EACH
15mm	5	08630	21.29
22mm	5	08631	27.33
28mm	1	08632	46.06
35mm	1	08633	67.76
42mm	1	08634	100.46
54mm	1	08635	111.27

YP37R
Sweep Tee, reduced branch
As YP37 but with reduced branch



SIZE	BOX QTY	CODE	£ EACH
22 x 22 x 15mm	5	08640	22.93
28 x 28 x 15mm	1	08641	38.96
28 x 28 x 22mm	1	08642	38.96
35 x 35 x 15mm	1	08643	67.76
35 x 35 x 22mm	1	08644	67.76

YP40
Offset Tee
All ends for copper

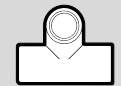

SIZE	BOX QTY	CODE	£ EACH
15 x 15 x 15mm	5	08650	28.12
22 x 22 x 15mm	5	08652	29.05
22 x 22 x 22mm	5	08651	33.80

YP43
Double Sweep Tee
All ends for copper



SIZE	BOX QTY	CODE	£ EACH
15mm	5	08655	24.05
22mm	1	08656	32.76
28mm	1	08657	49.74

YP50
Cross
All ends for copper

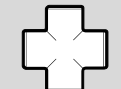

SIZE	BOX QTY	CODE	£ EACH
15mm	5	08660	31.82
22mm	5	08661	35.55
28mm	1	08662	51.01

YP60
Stop End
For insertion into fitting

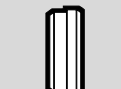

SIZE	BOX QTY	CODE	£ EACH
15mm	10	08665	8.23

YP61
Stop End
All ends for copper tube



SIZE	BOX QTY	CODE	£ EACH
8mm	10	08670	5.40
10mm	10	08672	5.38
12mm	10	08674	6.85
15mm	10	08680	3.09
22mm	10	08682	5.79
28mm	10	08684	10.32
35mm	1	08686	23.64
42mm	1	08688	40.72
54mm	1	08690	56.83

YP62
Tap Connector
Copper x BSP union nut
Spigot and washer joint



SIZE	BOX QTY	CODE	£ EACH
15mm x 3/8"	5	08695	19.04
15mm x 1/2"	5	08700	YPS
15mm x 3/4"	10	08702	9.35
22mm x 1/2"	5	08703	24.05
22mm x 3/4"	25	08710	4.82

YP63
Bent Tap Connector
Copper x BSP union nut
Spigot and washer joint



SIZE	BOX QTY	CODE	£ EACH
15mm x 1/2"	10	08720	4.78
22mm x 1/2"	5	08722	29.31
22mm x 3/4"	10	08723	14.66

YP63L
Long Bent Tap Connector
Copper x BSP union nut
Spigot and washer joint

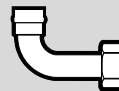

SIZE	BOX QTY	CODE	£ EACH
15mm x 1/2"	5	08724	14.19

YP64
Bent Union Adaptor
Copper x BSP union nut
Cone joint to BS 1010
In appropriate sizes suitable for copper cylinders with male bosses to BS 1010



SIZE	BOX QTY	CODE	£ EACH
15mm x 3/4"	5	08731	14.19
22mm x 1"	5	08732	19.58
28mm x 1 1/4"	1	08734	29.31

YP64CL
Bent Union Adaptor
Copper x BSP union nut
Spigot and washer joint
The 15mm x 3/4" size is suitable for connecting 15mm tube to a 3/4" pillar tap



SIZE	BOX QTY	CODE	£ EACH
15mm x 3/4"	5	08740	20.81
22mm x 1"	5	08741	24.11

YP64M
Meter Union Connector
Copper x BSP union nut
Suitable for use with gas meters

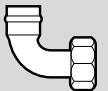

SIZE	BOX QTY	CODE	£ EACH
22mm x 3/4"	5	08745	17.77

YP65
Bent Male Union Connector
Copper x BSP taper male thread
Cone joint to BS 1010



SIZE	BOX QTY	CODE	£ EACH
12mm x 3/8"	5	08750	33.05
15mm x 1/2"	5	08751	24.51
22mm x 3/4"	5	08752	31.87
28mm x 1"	1	08753	45.58
35mm x 1 1/4"	1	08754	77.18
42mm x 1 1/2"	1	08755	125.45
54mm x 2"	1	08756	198.18

YP65F
Bent Female Union Connector
Copper x BSP taper female thread
Cone joint to BS 1010

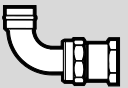

SIZE	BOX QTY	CODE	£ EACH
15mm x 1/2"	5	08766	24.51
22mm x 3/4"	5	08767	31.87
28mm x 1"	1	08768	45.58
35mm x 1 1/4"	1	08769	77.18
42mm x 1 1/2"	1	08770	125.45
54mm x 2"	1	08771	198.18

YP65P
Bent Female Union Connector
Copper x BSP parallel male thread
Cone joint to BS 1010



SIZE	BOX QTY	CODE	£ EACH
15mm x 1/2"	5	08775	24.51
22mm x 3/4"	5	08776	31.87
28mm x 1"	1	08777	45.58

YP General Range (contd)

YP65R
Bent Boiler Union
 Copper x BSP taper male thread
 Cone joint to BS 1010
 Reducing boiler union fitting for connecting primaries to boilers tapped 1" BSP
Built up using YP64 and YP71, supplied separately



SIZE	BOX QTY	CODE	£ EACH
22mm x 1"	1	08780	37.71

YP68
Union Adaptor
 Copper x BSP union nut
 Cone joint to BS 1010
In appropriate sizes suitable for copper cylinders with male bosses to BS 1010



SIZE	BOX QTY	CODE	£ EACH
15mm x 3/4"	10	08783	10.48
22mm x 1"	5	08784	14.87
28mm x 1 1/4"	1	08786	24.05
35mm x 1 1/2"	1	08788	38.44
42mm x 2"	1	08789	48.50
54mm x 2 1/2"	1	08790	74.92

YP68CL
Union Adaptor
 Copper x BSP union nut
 Cone joint to BS 1010
The 15mm x 3/4" size is suitable for connecting 15mm tube to a 3/4" pillar tap



SIZE	BOX QTY	CODE	£ EACH
15mm x 3/4"	5	08800	13.08
22mm x 1"	5	08801	17.85
28mm x 1 1/4"	1	08802	33.52

YP68FF
Flat Faced Union Adaptor
 Copper x BSP union nut
 Cone joint to BS 1010
Suitable for use with water meters



SIZE	BOX QTY	CODE	£ EACH
15mm x 3/4"	5	08796	12.95
22mm x 1"	5	08797	17.04

YP68M
Meter Union Connector
 Copper x BSP union nut
Suitable for use with gas meters



SIZE	BOX QTY	CODE	£ EACH
22mm x 3/4"	5	08795	12.13

YP69
Straight Male Union Connector
 Copper x BSP taper male thread
 Cone joint to BS 1010

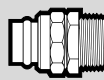

SIZE	BOX QTY	CODE	£ EACH
8mm x 1/4"	5	08810	22.12
12mm x 3/8"	5	08812	26.10
15mm x 1/2"	10	08813	20.87
22mm x 3/4"	10	08814	27.08
28mm x 1"	5	08816	40.36
35mm x 1 1/4"	1	08817	60.35
42mm x 1 1/2"	1	08818	94.79
54mm x 2"	1	08819	136.23

YP69DP
Straight Male Union Connector with Dip Pipe
 As YP69 but with 104mm dip pipe

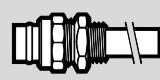

SIZE	BOX QTY	CODE	£ EACH
22mm x 3/4"	1	08825	33.62

YP69F
Straight Female Union Connector
 Copper x BSP parallel female thread
 Cone joint to BS 1010

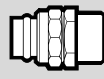

SIZE	BOX QTY	CODE	£ EACH
15mm x 1/2"	5	08833	20.87
22mm x 3/4"	5	08834	27.08
28mm x 1"	5	08835	40.36
35mm x 1 1/4"	1	08836	60.35
42mm x 1 1/2"	1	08837	94.79
54mm x 2"	1	08838	136.23

YP69P
Straight Male Union Connector
 Copper x BSP parallel male thread
 Cone joint to BS 1010



SIZE	BOX QTY	CODE	£ EACH
15mm x 1/2"	5	08840	20.87
22mm x 3/4"	5	08841	27.08
28mm x 1"	1	08842	40.36
67mm x 2 1/2"	1	08850	230.25

YP69R
Straight Boiler Union
 Copper x BSP taper male thread
 Cone joint to BS 1010
 Reducing boiler union fitting
Built up using YP68 and YP71, supplied separately

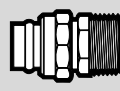

SIZE	BOX QTY	CODE	£ EACH
22mm x 1"	5	08855	33.02

YP70
Male Nipple
 Union thread x BSP taper male thread
 Cone joint to BS 1010
Enables YP64 and YP68 to be adapted to male union ends

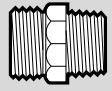

SIZE	BOX QTY	CODE	£ EACH
3/8" x 1/4"	5	08870	9.23
1/2" x 3/8"	5	08871	13.90
3/4" x 1/2"	5	08872	10.32
1" x 3/4"	5	08873	11.97
1 1/4" x 1"	1	08874	16.93
1 1/2" x 1 1/4"	1	08875	25.05
2" x 1 1/2"	1	08876	51.25
2 1/2" x 2"	1	08877	68.46

YP70P
Male Nipple
 Union thread x BSP parallel male thread
 Cone joint to BS 1010
 For use with YP64 and YP68 in providing boiler union fittings suitable for connection to parallel thread cylinder bosses

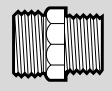

SIZE	BOX QTY	CODE	£ EACH
3/4" x 1/2"	5	08880	10.32
1" x 3/4"	5	08881	11.97
1 1/4" x 1"	1	08882	16.93

YP71
Male Nipple
 Union thread x BSP taper male thread, equal ends
 Cone joint to BS 1010



SIZE	BOX QTY	CODE	£ EACH
1/2"	10	08885	10.32
3/4"	5	08886	12.72
1"	5	08887	17.86
1 1/4"	1	08888	31.74

YP72
Female Nipple
 Union thread x BSP parallel female thread
 Cone joint to BS 1010
Enables YP64 and YP68 to be adapted to female union ends

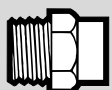

SIZE	BOX QTY	CODE	£ EACH
1/2" x 3/8"	5	08891	13.90
3/4" x 1/2"	5	08892	10.32
1" x 3/4"	5	08893	11.97
1 1/4" x 1"	1	08894	16.93
1 1/2" x 1 1/4"	1	08895	25.05
2" x 1 1/2"	1	08896	51.25
2 1/2" x 2"	1	08897	68.46



YP General Range (contd)

YP75

Nut and Lining

Male copper lining with loose coupling nut
Permits any capillary end to be provided with a union nut
Cone joint to BS 1010
For cylinder tees use the YP24 or YP26 etc with the YP75
To produce a male tee insert a YP70 into the YP75



SIZE	BOX QTY	CODE	£ EACH
15mm x 3/4"	5	08900	11.01

YP112

Stop End Floor Plate

One end for copper tube
Flange drilled with three countersunk holes for 3/16" diameter screws



SIZE	BOX QTY	CODE	£ EACH
15mm	1	08930	14.48
22mm	1	08932	19.83
28mm	1	08934	28.56

YP112A

Floor Plate

As YP112 but with through bore



SIZE	BOX QTY	CODE	£ EACH
15mm	1	08940	15.20

YP115

Extension Nipple

Used to give extra length to female ends on YP14, YP15, YP30 etc and to extend the tail of pillar taps to BS 1010

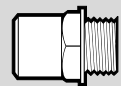

SIZE	BOX QTY	CODE	£ EACH
1/2"	10	08945	6.72
3/4"	5	08946	11.42

Unions with DZR Nuts

YP64 DZR

Bent Union Adaptor

Copper x BSP union nut
Cone joint to BS 1010
In appropriate sizes suitable to copper cylinders with male bosses to BS 1010
With DZR nuts



SIZE	BOX QTY	CODE	£ EACH
22mm x 1"	5	09011	19.90

YP68

Straight Union Adaptor

Copper x BSP union nut
Cone joint to BS 1010
In appropriate sizes suitable to copper cylinders with male bosses to BS 1010
With DZR nuts



SIZE	BOX QTY	CODE	£ EACH
15mm x 3/4"	5	09025	10.48
22mm x 1"	5	09026	15.18

YP68CL

Union Adaptor

Copper x BSP union nut
Spigot and washer joint
The 15mm x 3/4" size is suitable for connecting 15mm tube to a 3/4" pillar tap
With DZR nuts



SIZE	BOX QTY	CODE	£ EACH
15mm x 3/4"	5	09035	13.08
22mm x 1"	5	09036	17.85

Heating Components – Manifolds

1481

Linear Flow Manifold

Capillary socket inlet x four soft copper tube outlets, Patent No. 1278951
Supplied complete with 8mm Yorkshire couplings

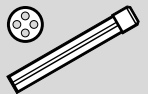

SIZE	BOX QTY	CODE	£ EACH
22 x 8mm	2	80050	31.57

1483

Linear Flow Manifold

Capillary socket inlet x four soft copper tube outlets, Patent No. 1278951
Supplied complete with 10mm Yorkshire couplings

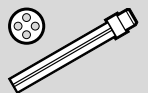

SIZE	BOX QTY	CODE	£ EACH
22 x 10mm	2	80053	40.73

1486

Linear Flow Manifold

Capillary socket inlet x six soft copper tube outlets, Patent No. 1278951
Supplied complete with 8mm Yorkshire couplings

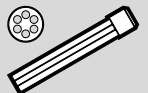

SIZE	BOX QTY	CODE	£ EACH
28 x 8mm	2	80060	45.38

1491

Side Entry Manifold

Capillary socket inlet x male end for insertion into fitting x four compression outlets
Side entry manifolds are supplied complete with nuts and rings

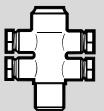

SIZE	BOX QTY	CODE	£ EACH
22 x 8mm	1	80070	36.80

1495

Side Entry Manifold

Capillary socket inlet x male end for insertion into fitting x two compression outlets
Side entry manifolds are supplied complete with nuts and rings

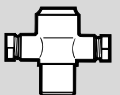

SIZE	BOX QTY	CODE	£ EACH
22 x 10mm	1	80072	24.03

1496

Side Entry Manifold

Capillary socket inlet x male end for insertion into fitting x four compression outlets
Side entry manifolds are supplied complete with nuts and rings

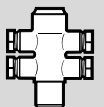

SIZE	BOX QTY	CODE	£ EACH
22 x 10mm	1	80073	38.38

Heating Components – Manifolds (contd)

**1478A
Compression Nut**
For side entry manifolds



SIZE	BOX QTY	CODE	£ EACH
8mm	100	83002	0.93
10mm	100	83003	1.78

**1478B
Compression Ring**
For side entry manifolds



SIZE	BOX QTY	CODE	£ EACH
8mm	100	83011	0.54
10mm	100	83012	0.93

**1478C
Blank Nut**
For blanking off outlets
Not required on side entry



SIZE	BOX QTY	CODE	£ EACH
8mm	100	83020	1.08
10mm	100	83021	2.46

**WM8
Micrafold**
Metric male copper ends x
10mm compression outlets
8 outlets
Internal disc soldered
centrally provides flow and
return chambers
Supplied with nut and rings



SIZE	BOX QTY	CODE	£ EACH
22 x 10mm	1	87102	74.83

**WM12
Micrafold**
Metric male copper ends x
10mm compression outlets
12 outlets
Internal disc soldered
centrally provides flow and
return chambers
Supplied with nut and rings

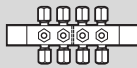

SIZE	BOX QTY	CODE	£ EACH
28 x 10mm	1	87101	109.33

**WM18
Micrafold**
Metric male copper ends x
10mm compression outlets
18 outlets
Internal disc soldered
centrally provides flow and
return chambers
Supplied with nut and rings



SIZE	BOX QTY	CODE	£ EACH
28 x 10mm	1	87100	148.41

**WM20
Blanking Plug**
Self sealing



SIZE	BOX QTY	CODE	£ EACH
10mm	100	87155	1.12

**WM21
Reducing Spacer with Olive**
Adapts 10mm compression
fittings to 8mm tube



SIZE	BOX QTY	CODE	£ EACH
10 x 8mm	100	87156	2.06

**WM22
Olive**



SIZE	BOX QTY	CODE	£ EACH
6mm	50	87162	0.65
8mm	50	87161	0.65
10mm	50	87160	0.65

**WM23
Nut**



SIZE	BOX QTY	CODE	£ EACH
10mm	100	87163	1.66

**WMS
Spanner**



SIZE	BOX QTY	CODE	£ EACH
N/A	1	87170	3.09

Waste Fittings

**YP6W
Reducer**
As YP6 but suitable for the
shorter socket of waste fittings



SIZE	BOX QTY	CODE	£ EACH
35 x 28mm	1	54001	11.42
42 x 35mm	1	54002	17.43
54 x 35mm	1	54003	29.97
54 x 42mm	1	54004	29.97

**YP62W
Waste Connector**
For connecting copper waste
pipe to screwed outlet of hand
basins, sinks etc where traps
are not used



SIZE	BOX QTY	CODE	£ EACH
35mm x 1 1/4"	1	54006	32.89
42mm x 1 1/2"	1	54007	45.26

Waste Fittings (contd)

**YP323
Copper Bend, 91.5°**
Copper x copper



SIZE	BOX QTY	CODE	£ EACH
35mm	1	54033	36.24
42mm	1	54034	60.48
54mm	1	54035	90.24

**YP359
Pitcher Tee, 88.5°**
Equal ends
Branch for connection
to outlet of trap tee

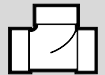

SIZE	BOX QTY	CODE	£ EACH
35mm	1	54055	52.26
42mm	1	54056	77.66
54mm	1	54057	106.94

**YP359R
Pitcher Tee, 88.5°**
Equal ends
Branch reduced, for connection
to outlet of trap tee

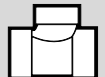

SIZE	BOX QTY	CODE	£ EACH
42 x 42 x 35mm	1	54058	77.66
54 x 54 x 35mm	1	54060	112.02
54 x 54 x 42mm	1	54059	112.02

**YP363
Pitcher Tee, 88.5°**
With screwed cleaning plug
Branch for connection to
outlet of trap tee



SIZE	BOX QTY	CODE	£ EACH
35mm	1	54067	58.65
42mm	1	54068	86.41
54mm	1	54069	124.45

**YP363R
Pitcher Tee, 88.5°**
Branch reduced for
connection to outlet of
trap tee

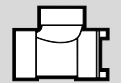

SIZE	BOX QTY	CODE	£ EACH
42 x 42 x 35mm	1	54070	86.43
54 x 54 x 35mm	1	54071	124.41
54 x 54 x 42mm	1	54072	124.41

**YP376
Sweep Cross, 88.5°**
Branch reduced for
connection to outlet of
trap tee



SIZE	BOX QTY	CODE	£ EACH
42mm	1	54090	115.48
54mm	1	54091	168.26



Waste Fittings (contd)

YP379

P Trap, 45° outlet

38mm (1½") seal

As used in layout for range of basins with exposed waste pipe to DoE/PSA requirements



SIZE	BOX QTY	CODE	£ EACH
35mm x 1¼"	1	54096	86.41

YP404

Running Trap, 90° outlet

38mm (1½") seal



SIZE	BOX QTY	CODE	£ EACH
42mm	1	54135	82.91
54mm	1	54136	119.34

YP407

Bath Trap, 88.5° outlet

Shallow seal

Fitted with 7/8" 20 t.p.i. (threads per inch) cleaning plug each side

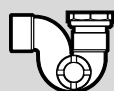

SIZE	BOX QTY	CODE	£ EACH
42mm x 1½"	1	54141	71.18

YP414

Running Trap, 90° outlet

76mm (3") seal



SIZE	BOX QTY	CODE	£ EACH
42mm	1	54148	134.46
54mm	1	54149	192.70

YP2001

Copper P Trap, 85° outlet

38mm (1½") seal generally

adjustable to BS 1184

Adjustable for depth and direction of outlet



SIZE	BOX QTY	CODE	£ EACH
35mm x 1¼"	1	54201	46.32
42mm x 1½"	1	54202	68.54

YP2002

Copper P Trap, 85° outlet

76mm (3") seal generally

to BS 1184

Adjustable for depth and direction of outlet



SIZE	BOX QTY	CODE	£ EACH
35mm x 1¼"	1	54205	49.87
42mm x 1½"	1	54206	71.06

YP2005

Copper S Trap

35mm (1¼") seal generally to BS 1184

Adjustable for depth and direction of outlet



SIZE	BOX QTY	CODE	£ EACH
35mm x 1¼"	1	54209	49.39

Stopvalves

YP501

Stopvalve

Copper x copper

With gunmetal body and brass headwork



SIZE	BOX QTY	CODE	£ EACH
15mm	5	05269	12.91
22mm	2	05270	24.11
28mm	2	05271	68.56

YP501DZR

All DZR Stopvalve

Copper x copper

The body and all parts in contact with water are made from material resistant to dezincification



SIZE	BOX QTY	CODE	£ EACH
15mm	5	05302	32.42
22mm	2	05303	56.16
28mm	2	05304	93.59

YP501GM

Gunmetal Stopvalve

Copper x copper

The body and all parts in contact with water are made from gunmetal



SIZE	BOX QTY	CODE	£ EACH
35mm	1	05305	146.80
42mm	1	05306	194.95
54mm	1	05307	291.20

YP505

Union Stopvalve

Copper x copper

With gunmetal body and brass headwork



SIZE	BOX QTY	CODE	£ EACH
22mm	2	05372	53.49

YP508

Double Union Stopvalve

Copper x copper

With gunmetal body and brass headwork

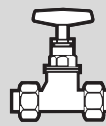

SIZE	BOX QTY	CODE	£ EACH
15mm	5	05441	41.82
22mm	2	05442	58.82
28mm	2	05443	104.64

YP508DZR

All DZR Double Union Stopvalve

Copper x copper

The body, union nuts and all parts in contact with water are made from material resistant to dezincification



SIZE	BOX QTY	CODE	£ EACH
15mm	5	05479	68.26
22mm	2	05480	83.91
28mm	2	05481	155.15

YP508GM

All Gunmetal Double

Union Stopvalve

Copper x copper

The body and all parts in contact with water are made from gunmetal



SIZE	BOX QTY	CODE	£ EACH
35mm	1	05482	258.47
42mm	1	05483	354.74
54mm	1	05484	558.03

YP515

Combined Stopvalve and Draining Tap

Copper x copper union inlet

With gunmetal body and brass headwork

Draining tap to BS 2879 Type 1

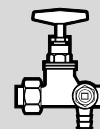

SIZE	BOX QTY	CODE	£ EACH
15mm	2	05757	71.86

YP515DZR

All DZR Combined Stopvalve and Draining Tap

Copper x copper

The body, union nut and all parts in contact with water are made from material resistant to dezincification

Draining tap to BS 2879 Type 1

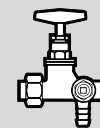

SIZE	BOX QTY	CODE	£ EACH
15mm	2	05773	94.99
22mm	2	05774	116.82

Gate Valves

YP415GM

Gate Valve

Copper x copper

The body and all parts in contact with water are made from gunmetal

To BS 5154/B

Yorkshire capillary ends

16 bar - 20°C : 6 bar - 110°C



SIZE	BOX QTY	CODE	£ EACH
15mm	5	05934	40.44
22mm	5	05935	46.82
28mm	2	05936	65.21
35mm	2	05937	145.42
42mm	2	05938	181.85
54mm	1	05939	263.81

Gate Valves (contd)

YP415GMLS All Gunmetal Lockshield Gate Valve

Copper x copper
The body and all parts in contact with water are made from gunmetal To BS 5154/B Yorkshire capillary ends As YP415GM but with lockshield



SIZE	BOX QTY	CODE	£ EACH
15mm	5	05940	41.82
22mm	5	05941	48.82
28mm	2	05942	75.91
35mm	2	05943	146.80
42mm	2	05944	181.85
54mm	2	05945	263.81

Plugcocks

YP202 Nited Plugcock

Copper x copper
Oblong bore suitable for low pressure gas services

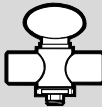

SIZE	BOX QTY	CODE	£ EACH
15mm	5	55201	29.71
22mm	5	55202	44.70

YP203 Nited Plugcock with Drophead

Copper x copper
Oblong bore suitable for low pressure gas services

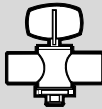

SIZE	BOX QTY	CODE	£ EACH
15mm	5	55207	33.74

YP205 Nited Union Plugcock

Copper x copper
Oblong bore suitable for low pressure gas services

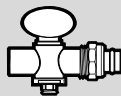

SIZE	BOX QTY	CODE	£ EACH
15mm	5	55218	34.45
22mm	5	55219	52.32

YP206 Nited Union Plugcock with Drophead

Copper x copper
Oblong bore suitable for low pressure gas services

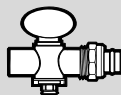

SIZE	BOX QTY	CODE	£ EACH
15mm	5	55230	39.06
22mm	5	55231	56.28

Draining Fittings

Refer to Kuterlite price list.

Pipe Clips and Brackets

101 Saddle Band Copper strip



SIZE	BOX QTY	CODE	£ EACH
6mm	100	71001	0.32
8mm	100	71002	0.32
10mm	100	71013	0.32
12mm	100	71003	0.32
15mm	100	71004	0.35
22mm	100	71005	0.35
28mm	100	71006	0.37
35mm	100	71007	0.63
42mm	100	71008	1.38
54mm	100	71009	1.83

102 Single Spacing Clip Unpolished brass strip



SIZE	BOX QTY	CODE	£ EACH
15mm	100	71010	0.37
22mm	100	71011	0.37
28mm	100	71012	0.93

103 Single Spacing Clip Copper strip Available as individual components



SIZE	BOX QTY	CODE	£ EACH
8mm Bottom	100	71041	0.32
8mm Top	100	71042	0.32
12mm Bottom	100	71043	0.32
12mm Top	100	71044	0.32
15mm Bottom	100	71029	0.35
15mm Top	100	71030	0.35
22mm Bottom	100	71031	0.35
22mm Top	100	71032	0.36
28mm Bottom	100	71033	0.35
28mm Top	100	71034	0.60
35mm Bottom	100	71035	0.38
35mm Top	100	71036	0.96

105 Pipe Bracket Unpolished brass strip



SIZE	BOX QTY	CODE	£ EACH
15mm	100	71023	4.28
22mm	100	71024	4.91
28mm	100	71025	5.88

107 Single Pipe Ring

Bright dipped finish
67mm, 76mm and 108mm sizes are supplied as polished castings



SIZE	BOX QTY	CODE	£ EACH
12mm tapped 1/8"	100	72501	11.36
15mm tapped 1/8"	25	72502	7.67
22mm tapped 1/8"	25	72503	8.20
28mm tapped 1/4"	25	72504	9.74
35mm tapped 1/4"	50	72505	10.91
42mm tapped 1/4"	50	72506	11.78
54mm tapped 3/8"	25	72507	14.23
67mm tapped 3/8"	20	72508	33.23
76mm tapped 1/2"	20	71045	41.97
108mm tapped 1/2"	15	71046	64.98

107M Metric Single Pipe Ring

Bright dipped finish
67mm, 76mm and 108mm sizes are supplied as polished castings
Tapped 10mm and suitable for all ring sizes



SIZE	BOX QTY	CODE	£ EACH
12mm tapped 10mm	100	72601	9.77
15mm tapped 10mm	100	72602	6.48
22mm tapped 10mm	100	72603	6.96
28mm tapped 10mm	50	72604	8.31
35mm tapped 10mm	50	72605	9.05
42mm tapped 10mm	50	72606	10.14
54mm tapped 10mm	50	72607	12.06
67mm tapped 10mm	20	72608	28.34
76mm tapped 10mm	15	72609	35.75
108mm tapped 10mm	15	72610	55.35

107D Double Pipe Ring

Bright dipped finish
67mm, 76mm and 108mm sizes are supplied as polished castings



SIZE	BOX QTY	CODE	£ EACH
15mm tapped 1/8"	25	72511	8.73
22mm tapped 1/4"	25	72512	9.29
28mm tapped 1/4"	25	72513	12.41
42mm tapped 3/8"	50	72515	14.58
54mm tapped 3/8"	50	72516	17.51
67mm tapped 1/2"	25	72517	37.50
108mm tapped 1/2"	15	71048	78.71

107DM Double Pipe Ring

Bright dipped finish
67mm, 76mm and 108mm sizes are supplied as polished castings



SIZE	BOX QTY	CODE	£ EACH
15mm tapped 10mm	100	72611	8.31
22mm tapped 10mm	100	72612	8.73
28mm tapped 10mm	50	72613	11.93



Pipe Clips and Brackets (contd)

108 Wall Bracket
Round backplate
Bright dipped finish



SIZE	BOX QTY	CODE	£ EACH
15mm	25	72520	10.95
22mm	25	72521	12.90
28mm	10	72522	15.71
35mm	25	72523	20.92
42mm	25	72524	27.77
54mm	25	72525	35.01

110 Hospital Bracket
Bright dipped finish

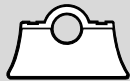

SIZE	BOX QTY	CODE	£ EACH
15mm	25	72536	9.29
22mm	25	72537	9.77
28mm	10	72538	11.98
35mm	25	72539	13.38
42mm	25	72540	18.79
54mm	20	72541	25.49

111 Male Backplate
For use with pipe rings
107 and 107D



SIZE	BOX QTY	CODE	£ EACH
12-22mm tapped 1/8"	25	72544	4.00
28-42mm tapped 1/4"	25	72546	5.51
54-67mm tapped 3/8"	10	72549	10.91
76-108mm tapped 1/2"	10	70191	17.37

111M Metric Male Backplate
For use with pipe rings
107M and 107D
Tapped 10mm and suitable
for all ring sizes



SIZE	BOX QTY	CODE	£ EACH
12-108mm	100	72621	3.64

116 Female Backplate
For use with pipe rings
107 and 107D



SIZE	BOX QTY	CODE	£ EACH
12-22mm tapped 1/8"	25	72554	4.28
28-42mm tapped 1/4"	25	72556	5.88
54-67mm tapped 3/8"	25	72559	11.28
76-108mm tapped 1/2"	10	71051	17.37

116M Metric Female Backplate
For use with pipe rings 107M
and 107DM. Tapped 10mm and
suitable for all ring sizes



SIZE	BOX QTY	CODE	£ EACH
12-108mm	100	72622	4.09

117S Split Threaded Iron Stem
For use with pipe rings 107 and
107D. Supplied in standard
lengths - plain shank 108mm (4")



SIZE	BOX QTY	CODE	£ EACH
12-22mm tapped 1/8"	25	72571	5.54
28-42mm tapped 1/4"	25	72572	6.09
54-67mm tapped 3/8"	25	72573	7.51

118 Threaded Iron Stem
Threaded both ends
For use with pipe rings 107 and
107D. Supplied in standard
lengths - plain shank 108mm (4")



SIZE	BOX QTY	CODE	£ EACH
12-22mm tapped 1/8"	25	72579	5.54
54-67mm tapped 3/8"	25	72581	7.51
76-108mm tapped 1/2"	25	72582	10.21

118B Threaded Brass Stem
For use with pipe rings 107 and
107D. Supplied in standard
lengths - plain shank 108mm (4")



SIZE	BOX QTY	CODE	£ EACH
12-22mm tapped 1/8"	10	72589	8.73
28-42mm tapped 1/4"	10	72590	10.91

118BM Threaded Brass Stem
1 metre length
For use with pipe rings 107 and
107D. Tapped 10mm and suitable
for all ring sizes



SIZE	BOX QTY	CODE	£ EACH
12-108mm	25	72623	75.51

Pipe Joist Clips

SPJ Single
Two-part clip, comprising a
zintec plate and polypropylene
body designed to protect
pipework, reduce vibration and
maintain joist strength



SIZE	BOX QTY	CODE	£ EACH
15mm	50	72640	1.88
22mm	50	72641	1.88

DPJ Double
Two-part clip, comprising a
zintec plate and polypropylene
body designed to protect
pipework, reduce vibration and
maintain joist strength



SIZE	BOX QTY	CODE	£ EACH
15mm	50	72642	2.61
22mm	50	72643	2.61

Pipe Joist Clips (contd)

DPJM Mixed Double
Two-part clip, comprising a
zintec plate and polypropylene
body designed to protect
pipework, reduce vibration and
maintain joist strength



SIZE	BOX QTY	CODE	£ EACH
15mm + 22mm	50	72644	2.61

JCT Template
For accurate joist cutting

MATERIAL	BOX QTY	CODE	£ EACH
Plastic	25	72645	3.43
Metal	25	72646	27.21

Chrome Plated

YP1CP Straight Coupling
Copper x copper

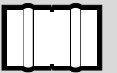

SIZE	BOX QTY	CODE	£ EACH
8mm	10	08002	8.16
12mm	10	08006	3.78
15mm	10	08011	1.79
22mm	10	08021	4.99
28mm	1	08031	10.35

YP11MCP Slip Adaptor Coupling
Imperial/metric
Copper x copper
To connect imperial tube to metric tube



SIZE	BOX QTY	CODE	£ EACH
3/4" x 22mm	1	08051	12.95

YP6CP Reducer
Larger male end for insertion
into fitting x female copper

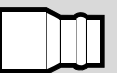

SIZE	BOX QTY	CODE	£ EACH
22 x 15mm	1	08201	7.14
28 x 15mm	1	08203	15.18
28 x 22mm	1	08205	6.69

YP12CP Elbow
Copper x copper

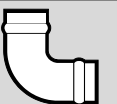

SIZE	BOX QTY	CODE	£ EACH
8mm	10	08267	17.43
12mm	10	08271	21.79
15mm	10	08281	3.67
22mm	10	08291	8.73
28mm	1	08301	19.73

Chrome Plated (contd)

**YP15CP
Backplate Elbow**
Copper x BSP parallel female thread. Triangular backplate, three hole fixing



SIZE	BOX QTY	CODE	£ EACH
15mm x 1/2"	1	08366	34.66

**YP24CP
Equal Tee**
All ends for copper

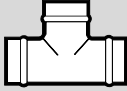

SIZE	BOX QTY	CODE	£ EACH
15mm	10	08451	6.51
22mm	5	08461	19.95
28mm	5	08463	30.47

**YP25CP
Tee, Reduced Branch**
All ends for copper



SIZE	BOX QTY	CODE	£ EACH
22 x 22 x 15mm	5	08491	16.35

**YP26CP
Tee, one end reduced**
All ends for copper



SIZE	BOX QTY	CODE	£ EACH
22 x 15 x 22mm	1	08511	30.74

**YP27CP
Tee, one end and brand reduced**
All ends for copper



SIZE	BOX QTY	CODE	£ EACH
22 x 15 x 15mm	5	08531	25.80

**YP28CP
Tee, both ends reduced**
All ends for copper



SIZE	BOX QTY	CODE	£ EACH
15 x 15 x 22mm	1	08552	25.65

**YP61CP
Stop End**
For use with copper tube



SIZE	BOX QTY	CODE	£ EACH
15mm	10	08681	11.86
22mm	1	08683	13.80
28mm	1	08685	24.22

**YP62CP
Straight Tap Connector**
Copper x union nut Spigot and washer joint

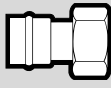

SIZE	BOX QTY	CODE	£ EACH
15mm x 1/4"	5	08701	14.77
22mm x 3/4"	5	08711	20.76

**YP63CP
Bent Tap Connector**
Copper x union nut Spigot and washer joint

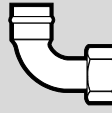

SIZE	BOX QTY	CODE	£ EACH
15mm x 1/2"	1	08721	17.02

Special Finishes

These fittings are commercial quality chrome plated. Polished quality is also available.

YPS Range – Polished Chrome

**YPS12S
Street Elbow**
Female copper x male copper for insertion into fitting



SIZE	BOX QTY	CODE	£ EACH
22 x 15mm	1	08318CP	4.08

**YPS24
Equal Tee**
All ends for copper



SIZE	BOX QTY	CODE	£ EACH
22mm	1	08460CP	12.39

YP General Range – Polished Chrome

**YP1
Straight Coupling**
Copper x copper

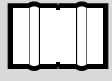

SIZE	BOX QTY	CODE	£ EACH
10mm	1	08003CP	3.18
15mm	1	08010CP	1.17
22mm	1	08020CP	3.05
28mm	1	08030CP	6.72
35mm	1	08032CP	22.71
42mm	1	08034CP	37.92

**YP1R
Reducing Coupling**
Copper x copper



SIZE	BOX QTY	CODE	£ EACH
22 x 15mm	1	08063CP	13.18
54 x 42mm	1	08072CP	126.47

**YP2
Adaptor Coupling**
Straight female connector Copper x BSP parallel female thread



SIZE	BOX QTY	CODE	£ EACH
15mm x 1/2"	1	08090CP	16.57
22mm x 3/4"	1	08092CP	24.00

YP General Range – Polished Chrome (contd)

**YP2LC
Female Reducing Connector**
Straight female connector As YP2 but with reduced BSP female end



SIZE	BOX QTY	CODE	£ EACH
15mm x 1/4"	1	08101CP	29.39

**YP3
Straight Male Connector**
Copper x BSP taper male thread



SIZE	BOX QTY	CODE	£ EACH
15mm x 1/2"	1	08114CP	14.09
22mm x 3/4"	1	08116CP	25.15
28mm x 1"	1	08118CP	40.62

**YP6
Reducer**
Larger end male copper for insertion into fitting x female copper



SIZE	BOX QTY	CODE	£ EACH
15 x 10mm	1	08196CP	4.50
42 x 22mm	1	08210CP	78.92
42 x 35mm	1	08212CP	61.07
54 x 22mm	1	08214CP	152.96
54 x 35mm	1	08216CP	128.17
54 x 42mm	1	08217CP	110.55

**YP12
Elbow**
Copper x copper



SIZE	BOX QTY	CODE	£ EACH
10mm	1	08268CP	5.38
15mm	1	08280CP	2.05
22mm	1	08290CP	5.35
28mm	1	08300CP	10.75
35mm	1	08302CP	48.62
42mm	1	08304CP	80.35
54mm	1	08306CP	165.97
67mm	1	08308CP	430.76

**YP12R
Reducing Elbow**
As YP12 but with one end reduced



SIZE	BOX QTY	CODE	£ EACH
22 x 15mm	1	08310CP	37.10

**YP12S
Street Elbow**
Female copper x male copper for insertion into fitting



SIZE	BOX QTY	CODE	£ EACH
22mm	1	08320CP	12.06
35mm	1	08324CP	81.93

YP General Range – Polished Chrome (contd)

**YP14
Female Elbow**
Copper x BSP parallel female thread

SIZE	BOX QTY	CODE	£ EACH
15mm x 1/2"	1	08351CP	24.30

**YP21
Obtuse Elbow**
Copper x copper

SIZE	BOX QTY	CODE	£ EACH
15mm	1	08410CP	5.66
22mm	1	08412CP	11.82
35mm	1	08416CP	73.38
42mm	1	08417CP	130.63
54mm	1	08418CP	236.29

**YP23
Full Crossover**
Copper x copper

SIZE	BOX QTY	CODE	£ EACH
15mm	1	08430CP	31.94

**YP24
Equal Tee**
All ends for copper

SIZE	BOX QTY	CODE	£ EACH
15mm	1	08450CP	3.89
28mm	1	08462CP	29.91
35mm	1	08464CP	79.16
42mm	1	08466CP	127.01
54mm	1	08467CP	256.12

**YP24S
Equal Tee Slip Pattern**
All ends for copper

SIZE	BOX QTY	CODE	£ EACH
22mm	1	08476CP	43.51

**YP25
Tee, reduced branch**
All ends for copper

SIZE	BOX QTY	CODE	£ EACH
22 x 15mm	1	08490CP	9.82
28 x 28 x 15mm	1	08492CP	41.50
28 x 22mm	1	08494CP	44.20
35 x 35 x 22mm	1	08497CP	86.40
42 x 42 x 35mm	1	08502CP	239.70
54 x 54 x 22mm	1	08504CP	367.47
54 x 54 x 35mm	1	08506CP	384.89

**YP26
Tee, one end reduced**
All ends for copper

SIZE	BOX QTY	CODE	£ EACH
28 x 15mm	1	08512CP	66.15
28 x 22mm	1	08514CP	60.46
35 x 22 x 35mm	1	08517CP	111.00

**YP27
Tee, one end and branch reduced**
All ends for copper

SIZE	BOX QTY	CODE	£ EACH
28 x 15 x 15mm	1	08532CP	74.76
28 x 15 x 22mm	1	08534CP	86.78
28 x 22 x 15mm	1	08536CP	60.84
28 x 22mm	1	08538CP	55.27
35 x 28 x 22mm	1	08541CP	116.67
35 x 28 x 28mm	1	08542CP	102.66

**YP28
Tee, both ends reduced**
All ends for copper

SIZE	BOX QTY	CODE	£ EACH
22 x 22 x 28mm	1	08555CP	59.52
28 x 28 x 35mm	1	08558CP	118.30

**YP29
Female Tee**
Copper end and branch x BSP parallel female end

SIZE	BOX QTY	CODE	£ EACH
15mm x 1/2" x 15mm	1	08570CP	23.21

**YP29R
Female Tee**
As YP29 but with reduced female BSP end

SIZE	BOX QTY	CODE	£ EACH
22mm x 1/2"	1	08575CP	39.45

**YP30
Female Tee**
Copper ends x BSP parallel female branch

SIZE	BOX QTY	CODE	£ EACH
15 x 15mm x 1/2"	1	08585CP	18.17

**YP37R
Sweep Tee, reduced branch**
As YP37 but with reduced branch

SIZE	BOX QTY	CODE	£ EACH
28 x 22mm	1	08642CP	91.53

**YP61
Stop End**
All ends for copper tube

SIZE	BOX QTY	CODE	£ EACH
22mm	1	08682CP	13.58
28mm	1	08684CP	24.25

**YP63
Bent Tap Connector**
Copper x BSP union nut Spigot and washer joint

SIZE	BOX QTY	CODE	£ EACH
22mm x 3/4"	1	08723CP	34.42

**YP69
Straight Male Union Connector**
Copper x BSP taper male thread Cone joint to BS 1010

SIZE	BOX QTY	CODE	£ EACH
15mm x 1/2"	1	08813CP	49.03
22mm x 3/4"	1	08814CP	63.64
28mm x 1"	1	08816CP	94.82

**YP70
Male Nipple**
Union thread x BSP taper male thread Cone joint to BS 1010
Enables YP64 and YP68 to be adapted to male union ends

SIZE	BOX QTY	CODE	£ EACH
3/8" x 1/4"	1	08870CP	21.70
1/2" x 3/8"	1	08871CP	32.63

**YP112
Stop End Floor Plate**
One end for copper tube Flange drilled with three countersunk holes for 3/16" diameter screws

SIZE	BOX QTY	CODE	£ EACH
22mm	1	08932CP	46.59

Waste Fittings – Polished Chrome

YP6W Reducer
As YP6 but suitable for the shorter socket of waste fittings



SIZE	BOX QTY	CODE	£ EACH
42 x 35mm	1	54002CP	40.94
54 x 35mm	1	54003CP	70.45
54 x 42mm	1	54004CP	70.45

YP62W Waste Connector
For connecting copper waste pipe to screwed outlet of hand basins, sinks etc where traps are not used



SIZE	BOX QTY	CODE	£ EACH
42mm x 1/2"	1	54007CP	106.36

YP323 Copper Bend, 91.5°
Copper x copper



SIZE	BOX QTY	CODE	£ EACH
35mm	1	54033CP	85.17
42mm	1	54034CP	142.12
54mm	1	54035CP	212.07

YP359 Pitcher Tee, 88.5°
Equal ends
Branch for connection to outlet of trap tee



SIZE	BOX QTY	CODE	£ EACH
35mm	1	54055CP	122.80
42mm	1	54056CP	182.48
54mm	1	54057CP	251.31

YP359R Pitcher Tee, 88.5°
Equal ends
Branch reduced, for connection to outlet of trap tee



SIZE	BOX QTY	CODE	£ EACH
42 x 42 x 35mm	1	54058CP	182.48
54 x 54 x 42mm	1	54059CP	263.23
54 x 35mm	1	54060CP	263.23

YP363 Pitcher Tee, 88.5°
With screwed cleaning plug
Branch for connection to outlet of trap tee



SIZE	BOX QTY	CODE	£ EACH
35mm	1	54067CP	137.84
42mm	1	54068CP	203.06
54mm	1	54069CP	292.43

YP363R Pitcher Tee, 88.5°
Branch reduced for connection to outlet of trap tee



SIZE	BOX QTY	CODE	£ EACH
42 x 42 x 35mm	1	54070CP	203.10
54 x 54 x 35mm	1	54071CP	292.37
54 x 54 x 42mm	1	54072CP	292.37

YP2001 Copper P Trap, 85° outlet
38mm (1 1/2") seal generally adjustable to BS 1184
Adjustable for depth and direction of outlet



SIZE	BOX QTY	CODE	£ EACH
35mm x 1 1/4"	1	54201CP	108.85

YP2002 Copper P Trap, 85° outlet
76mm (3") seal generally to BS 1184
Adjustable for depth and direction of outlet



SIZE	BOX QTY	CODE	£ EACH
35mm x 1 1/4"	1	54205CP	117.16
42mm x 1 1/2"	1	54206CP	166.98

Gate Valves – Polished Chrome

YP415GM All Gunmetal Gate Valve
Copper x copper
The body and all parts in contact with water are made from gunmetal
To BS 5154/B
Yorkshire capillary ends
16 bar - 20°C : 6 bar - 110°C



SIZE	BOX QTY	CODE	£ EACH
15mm	1	05934CP	94.12

YP415GMLS All Gunmetal Lockshield Gate Valve
Copper x copper
The body and all parts in contact with water are made from gunmetal
To BS 5154/B
Yorkshire capillary ends
As YP415GM but with lockshield



SIZE	BOX QTY	CODE	£ EACH
15mm	1	05940CP	97.34

Pipe Clips and Brackets – Polished Chrome

101 Saddle Band
Copper strip



SIZE	BOX QTY	CODE	£ EACH
15mm	1	71004CP	0.81

Pipe Clips and Brackets – Polished Chrome (contd)

102 Single Spacing Clip
Unpolished brass strip



SIZE	BOX QTY	CODE	£ EACH
15mm	1	71010CP	0.87

103 Single Spacing Clip
Copper strip
Available as individual components



SIZE	BOX QTY	CODE	£ EACH
15mm Bottom	1	71029CP	0.81
15mm Top	1	71030CP	0.81
22mm Bottom	1	71031CP	0.81
22mm Top	1	71032CP	0.83
28mm Bottom	1	71033CP	0.81
28mm Top	1	71034CP	1.45
35mm Bottom	1	71035CP	0.91
35mm Top	1	71036CP	2.26

105 Pipe Bracket
Unpolished brass strip



SIZE	BOX QTY	CODE	£ EACH
15mm	1	71023CP	10.08
22mm	1	71024CP	11.57
28mm	1	71025CP	13.80

107 Single Pipe Ring
Bright dipped finish
67mm, 76mm and 108mm sizes are supplied as polished castings



SIZE	BOX QTY	CODE	£ EACH
15mm	1	72502CP	18.01
22mm	1	72503CP	19.25
54mm	1	72507CP	33.43

108 Wall Bracket
Round backplate
Bright dipped finish



SIZE	BOX QTY	CODE	£ EACH
15mm	1	72520CP	25.75
22mm	1	72521CP	30.28
35mm	1	72523CP	49.16

110 Hospital Bracket
Bright dipped finish

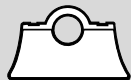

SIZE	BOX QTY	CODE	£ EACH
15mm	1	72536CP	21.83
22mm	1	72537CP	22.98
28mm	1	72538CP	28.12

111 Male Backplate
For use with pipe rings 107 and 107D



SIZE	BOX QTY	CODE	£ EACH
12-22mm	1	72544CP	9.36
54-67mm	1	72549CP	25.64



Pipe Clips and Brackets – Polished Chrome

111M

Metric Male Backplate

For use with pipe rings 107M and 107D Tapped 10mm and suitable for all ring sizes



SIZE	BOX QTY	CODE	£ EACH
12-108mm	1	72621CP	8.55

Accessories

130

Yorkshire Flux

A COSHH sheet for this product is available under the Technical section of our website



SIZE	BOX QTY	CODE	£ EACH
100g carton	1	70212	9.44
500g carton	1	70213	20.28

131

Traditional Craftsman's Flux

Grease based flux A COSHH sheet for this product is available under the Technical section of our website



SIZE	BOX QTY	CODE	£ EACH
100g carton	1	70214	6.92
500g carton	1	70215	18.31

Easy Flow Flux

Grease based flux A COSHH sheet for this product is available under the Technical section of this website

SIZE	BOX QTY	CODE	£ EACH
250g carton	1	21066	39.21

140

Re-rounding Tool

For re-forming distorted soft copper (R220) tube ends



SIZE	BOX QTY	CODE	£ EACH
8mm	10	71098	105.67
10mm	10	71097	105.67
12mm	10	71099	105.67
15mm	10	71100	96.06
22mm	10	71101	105.67
28mm	5	71102	105.67
35mm	5	71103	159.51
42mm	5	71104	199.36
54mm	2	71105	269.13

141

Tube Bender

A hand forming tool designed to put bends in Minibore copper tube Patent No. 1333625



SIZE	BOX QTY	CODE	£ EACH
6/8mm	1	71080	12.23
10mm	1	71079	15.09

142

Tube Straightener

As Minibore tubing is supplied in compact pancake coils, some form of straightening is required prior to installation, particularly where the tube is to be surface fixed Reg. Design No. 956301



SIZE	BOX QTY	CODE	£ EACH
6/8mm	1	71081	13.47
8/10mm	1	71082	13.47

145

Cleaning Pads

Highly abrasive synthetic cleaning pad for cleaning tube ends and bores of Yorkshire and Endex fittings

SIZE	BOX QTY	CODE	£ EACH
Pack of 2	1	71070	9.83

146

Steel Wool

Highly abrasive synthetic cleaning pad for cleaning tube ends and bores of Yorkshire and Endex fittings

SIZE	BOX QTY	CODE	£ EACH
450g/1lb pack	1	21060	12.25
16 pad pack	1	71060	13.00

CM4

Heat Resistant Mat

Ceramic fibre heat resistant mat

SIZE	BOX QTY	CODE	£ EACH
300mm x 250mm	1	21063	38.75

CM5

Heat Resistant Mat

High quality ceramic fibre heat resistant mat

SIZE	BOX QTY	CODE	£ EACH
300mm x 200mm	1	21062	87.26

SK2

3 Ended Key

For lockshield stopvalves

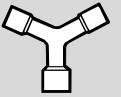

SIZE	BOX QTY	CODE	£ EACH
15 - 28mm	25	73190	12.52

SK3

3 Ended Key

For lockshield stopvalves

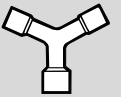

SIZE	BOX QTY	CODE	£ EACH
35 - 54mm	10	73191	20.91

VK3

3 Ended Key

For lockshield stop valves

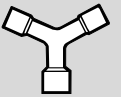

SIZE	BOX QTY	CODE	£ EACH
15 - 54mm	10	71544	15.09

FW1

Tap Connector Washers

Also suitable for Kuterlite and Endex tap connectors



SIZE	PACK QTY	CODE	£ EACH
3/8"	100	71220	0.21
1/2"	100	73050	0.21
3/4"	100	73051	0.24

FW2

Union Connector Washers



SIZE	BOX QTY	CODE	£ EACH
3/4"	100	71310	0.24
1"	100	71223	0.26
1 1/4"	50	71311	0.27

Sundries

450 Brass Plug
Hexagonal head
BSP parallel male thread



SIZE	BOX QTY	CODE	£ EACH
1/8"	50	72625	4.09
1/4"	25	72626	4.09
3/8"	25	72627	4.64

450DZR DZR Plug
Square head
BSP parallel male thread



SIZE	BOX QTY	CODE	£ EACH
1/2"	25	72628	8.66
3/4"	25	72629	10.12
1"	25	72630	12.38

452 Brass Plug
Castellated head
BSP parallel male thread



SIZE	BOX QTY	CODE	£ EACH
7/8" (20 t.p.i.)	25	70115	12.38
1"	25	70116	12.38
1 1/4"	10	70117	21.63
1 1/2"	10	70118	28.06

456DZR DZR Backnut
BSP thread with flange



SIZE	BOX QTY	CODE	£ EACH
1/2"	100	70102	3.05
3/4"	100	70103	3.59
1"	50	70104	5.28
1 1/4"	25	70105	6.93
1 1/2"	10	70106	8.40
2"	5	70107	11.07
2 1/2"	5	70108	22.46

462DZR DZR Hexagonal Nipple
BSP taper male thread



SIZE	BOX QTY	CODE	£ EACH
1/2"	25	72679	9.24
3/4"	25	72680	11.26
1"	10	72681	15.44

464 Hexagonal Bush
Screwed inside and outside
BSP taper male thread



SIZE	BOX QTY	CODE	£ EACH
1/4" x 1/8"	25	72694	3.05
3/8" x 1/4"	25	72695	3.59

464DZR Hexagonal DZR Bush
Screwed inside and outside
BSP taper male thread



SIZE	BOX QTY	CODE	£ EACH
1/2" x 1/4"	25	72696	5.28
1/2" x 3/8"	25	72697	4.09
3/4" x 1/2"	10	72700	5.28
1" x 1/2"	10	72702	9.24
1" x 3/4"	10	72703	7.28
1 1/4" x 1"	10	72706	14.49

470DZR Blank DZR Hexagonal Nut
BSP thread
Supplied with a washer



SIZE	BOX QTY	CODE	£ EACH
1/2"	25	70171	4.09
3/4"	25	70172	4.64
1"	25	70173	6.62

472 Hexagonal Brass Nut
BSP thread
Suitable for use on union fittings
in place of standard octagonal
nut in appropriate sizes

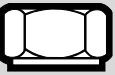

SIZE	BOX QTY	CODE	£ EACH
3/4"	25	70013	4.19
1 1/2"	10	70016	11.66
2"	5	70017	16.99
2 1/2"	5	70018	26.59

472DZR Hexagonal DZR Nut
BSP thread
Suitable for use on union
fittings in place of standard
octagonal nut in appropriate
sizes. Made from dezincification
resistant material



SIZE	BOX QTY	CODE	£ EACH
1/2"	50	70027	6.12
3/4"	25	70028	8.13
1"	25	70029	11.76
1 1/4"	10	70030	16.99
1 1/2"	10	70031	23.35
2"	5	70032	31.96
2 1/2"	5	70033	39.83

474 Octagonal Union Nut
BSP thread
As used on standard
union connectors etc



SIZE	BOX QTY	CODE	£ EACH
3/4"	25	70045	3.59
1"	25	70046	5.28
1 1/4"	10	70047	7.91

GHD Fittings

1GHD Straight Coupling
Copper x copper



SIZE	BOX QTY	CODE	£ EACH
6mm	10	56001	11.99
8mm	10	56002	10.02
12mm	10	56004	7.32
15mm	10	56005	6.69
22mm	10	56007	10.70
28mm	10	56008	15.18
35mm	1	56009	27.75
42mm	1	56010	30.32
54mm	1	56011	44.63

1RGHD Reducing Coupling
Copper x copper



SIZE	BOX QTY	CODE	£ EACH
12 x 8mm	10	56029	14.00
15 x 8mm	10	56032	12.58
15 x 12mm	10	56034	12.58
22 x 15mm	10	56038	14.58
28 x 22mm	1	56042	20.11

2GHD Straight Female Connector
Copper x BSP parallel
female thread



SIZE	BOX QTY	CODE	£ EACH
8mm x 1/4"	10	56081	14.00
15mm x 1/2"	10	56084	16.44
22mm x 3/4"	10	56086	18.53
28mm x 1"	5	56087	27.31

3GHD Straight Male Connector
Copper x BSP taper
male thread



SIZE	BOX QTY	CODE	£ EACH
8mm x 1/4"	10	56102	13.39
15mm x 1/2"	10	56105	15.99
22mm x 3/4"	5	56107	18.53
28mm x 1"	1	56108	27.31
42mm x 1 1/2"	1	56110	55.34
54mm x 2"	1	56111	89.91

6GHD Reducer
Larger end male copper for
insertion into fitting x
female copper

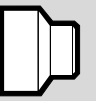

SIZE	BOX QTY	CODE	£ EACH
8 x 6mm	5	56134	9.10
12 x 8mm	5	56137	9.10
15 x 8mm	10	56140	8.25
15 x 12mm	10	56142	8.25
22 x 15mm	10	56147	8.08
28 x 15mm	10	56150	14.58
28 x 22mm	10	56152	14.58
35 x 28mm	1	56156	19.23
42 x 28mm	1	56160	25.09
42 x 35mm	1	56161	24.78
54 x 28mm	1	56163	39.96
54 x 42mm	1	56165	39.96

GHD Fittings

7GHD Adaptor

Male copper for insertion into fitting x BSP parallel female thread

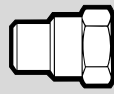

SIZE	BOX QTY	CODE	£ EACH
15mm x 1/2"	10	56199	24.75
22mm x 3/4"	1	56201	25.23

8GHD Adaptor

Male copper for insertion into fitting x BSP taper male thread

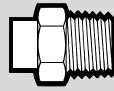

SIZE	BOX QTY	CODE	£ EACH
15mm x 1/2"	10	56220	24.75
22mm x 3/4"	5	56222	25.23

9GHD Adaptor

Imperial/metric To connect imperial fittings to metric fittings

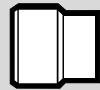

SIZE	BOX QTY	CODE	£ EACH
1/2" x 15mm	5	56232	8.73
3/4" x 22mm	5	56233	11.19
1" x 28mm	1	56234	15.28
1 1/4" x 35mm	1	56235	22.20

11GHD Union coupling

Copper x copper

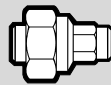

SIZE	BOX QTY	CODE	£ EACH
8mm	10	56249	26.64
12mm	10	56251	26.64
15mm	10	56252	30.09
22mm	5	56254	38.51
28mm	1	56255	53.45
35mm	1	56256	96.81
42mm	1	56257	114.04

11SGHD Street Union Coupling

Female copper x male copper for insertion into fitting Round-nose to cone joint Supplied as loose components

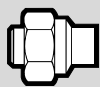

SIZE	BOX QTY	CODE	£ EACH
12mm	10	56270	27.85
15mm	10	56271	30.09

12GHD Elbow

Copper x copper



SIZE	BOX QTY	CODE	£ EACH
8mm	10	56289	20.04
12mm	10	56291	21.37
15mm	10	56292	19.38
22mm	10	56294	20.67
28mm	5	56295	30.74
35mm	1	56296	49.89
42mm	1	56297	62.13
54mm	1	56298	108.06

20GHD Return Bend

Copper x copper

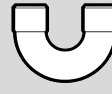

SIZE	BOX QTY	CODE	£ EACH
28mm	1	56320	63.05
35mm	1	56321	76.01

24GHD Equal Tee

All ends for copper



SIZE	BOX QTY	CODE	£ EACH
8mm	10	56336	18.81
12mm	10	56338	23.32
15mm	10	56339	22.24
22mm	10	56341	27.98
28mm	1	56342	36.87
35mm	1	56343	65.44
42mm	1	56344	83.30
54mm	1	56345	131.17

25GHD Reduced Branch Tee

All ends for copper



SIZE	BOX QTY	CODE	£ EACH
15 x 8mm	5	56350	30.51
15 x 12mm	5	56355	30.51
22 x 15mm	5	56360	36.03
28 x 15mm	5	56365	51.44
28 x 22mm	5	56370	51.44
35 x 28mm	1	56375	84.66
42 x 28mm	1	56380	108.39
54 x 28mm	1	56385	171.17

61GHD Stop End

For use on copper tube



SIZE	BOX QTY	CODE	£ EACH
15mm	10	56470	14.58

64GHD Bent Union Adaptor

Copper x BSP union nut Round-nose to cone joint

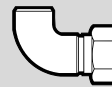

SIZE	BOX QTY	CODE	£ EACH
8mm x 3/8"	10	56485	35.34
12mm x 1/2"	10	56487	38.51
15mm x 3/4"	10	56488	34.71
22mm x 1"	5	56490	46.83
28mm x 1 1/4"	1	56491	65.44

65GHD Bent Male Union Connector

Copper x BSP taper male thread Round-nose to cone joint

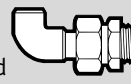

SIZE	BOX QTY	CODE	£ EACH
8mm x 1/4"	5	56507	42.35
12mm x 3/8"	5	56509	45.55
15mm x 1/2"	5	56510	44.88
22mm x 3/4"	5	56512	60.48
28mm x 1"	1	56513	109.89

68GHD Straight Union Adaptor

Copper x BSP union nut Round-nose to cone joint



SIZE	BOX QTY	CODE	£ EACH
6mm x 1/4"	5	56535	14.58
8mm x 3/8"	10	56536	12.15
12mm x 1/2"	10	56538	13.35
15mm x 3/4"	10	56539	13.35
22mm x 1"	5	56541	18.07
28mm x 1 1/4"	1	56542	24.78
35mm x 1 1/2"	1	56543	44.91
42mm x 2"	1	56544	56.87

69GHD Straight Male Union Connector

Copper x BSP taper male thread Round-nose to cone joint

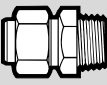

SIZE	BOX QTY	CODE	£ EACH
6mm x 1/8"	5	56557	24.51
8mm x 1/4"	10	56558	19.19
12mm x 3/8"	5	56560	20.26
15mm x 1/2"	5	56561	23.61
22mm x 3/4"	5	56563	31.71
28mm x 1"	1	56564	70.71
35mm x 1 1/4"	1	56565	93.52
42mm x 1 1/2"	1	56566	112.35

70GHD Male Hexagon Nipple

BSP union thread x BSP taper male thread 60° cone

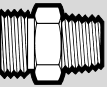

SIZE	BOX QTY	CODE	£ EACH
1/4" x 1/8"	5	56596	10.02
3/8" x 1/4"	5	56597	7.04
1/2" x 3/8"	10	56598	6.99
3/4" x 1/2"	5	56599	10.23
1" x 3/4"	5	56600	13.63
1 1/4" x 1"	1	56601	48.60
1 1/2" x 1 1/4"	1	56602	48.60
2" x 1 1/2"	1	56603	55.47

70PGHD Male Hexagon Nipple

BSP union thread x BSP parallel male thread 60° cone

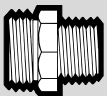

SIZE	BOX QTY	CODE	£ EACH
1/4" x 1/8"	5	56610	10.02
3/8" x 1/4"	10	56611	7.04
1/2" x 3/8"	5	56612	6.99
3/4" x 1/2"	10	56613	10.23
1" x 3/4"	5	56614	13.63
1 1/4" x 1"	1	56615	48.60
1 1/2" x 1 1/4"	1	56618	48.60

75GHD Nut and Lining

Male copper lining for insertion into fitting with loose BSP union joint Round-nose to cone joint

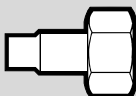

SIZE	BOX QTY	CODE	£ EACH
8mm x 3/8"	5	56638	15.18
15mm x 3/4"	5	56641	15.61
22mm x 1"	5	56643	26.78

GHD Fittings (contd)

77GHD Union Adaptor
Male copper for insertion into fitting x BSP union thread 60° cone



SIZE	BOX QTY	CODE	£ EACH
12mm x 1/2"	5	56660	14.58
15mm x 3/4"	5	56661	16.84
22mm x 1"	5	56663	20.11

150GHD Deck or Bulkhead Straight Union Connector
Copper x copper
Suitable for 25mm deck thickness

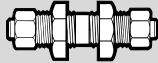

SIZE	BOX QTY	CODE	£ EACH
15mm	1	56704	99.99

GHD Accessories

130GHD High Duty Flux
Ready mix paste

SIZE	BOX QTY	CODE	£ EACH
500g tub	1	21068	39.21

N165 Silver-flo Brazing Alloy
To BS EN 1044 AG14 (formerly BS 1845)

SIZE	BOX QTY	CODE	£ EACH
250g reel	1	71157	Refer to Endex price list

N166 Silver Alloy Brazing Rods
To BS EN 1044 AG14 (formerly BS 1845)

SIZE	BOX QTY	CODE	£ EACH
3mm x 600mm	1	71175	Refer to Endex price list

GHD Fittings Degreased

1GHD Straight Coupling
Copper x copper



SIZE	BOX QTY	CODE	£ EACH
6mm	1	56001DW	14.99
15mm	1	56005DW	8.36
22mm	1	56007DW	13.38
28mm	1	56008DW	18.96
35mm	1	56009DW	30.51
42mm	1	56010DW	33.35

1RGHD Reducing Coupling
Copper x copper



SIZE	BOX QTY	CODE	£ EACH
22 x 15mm	1	56038DW	18.24

2GHD Straight Female Connector
Copper x BSP parallel female thread

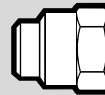

SIZE	BOX QTY	CODE	£ EACH
15mm x 1/2"	1	56084DW	20.56
22mm x 3/4"	1	56086DW	23.17
28mm x 1"	1	56087DW	34.16

3GHD Straight Male Connector
Copper x BSP taper male thread



SIZE	BOX QTY	CODE	£ EACH
15mm x 1/2"	1	56105DW	19.99
22mm x 3/4"	1	56107DW	23.17
28mm x 1"	1	56108DW	34.16
42mm x 1 1/2"	1	56110DW	60.87
54mm x 2"	1	56111DW	98.91

6GHD Reducer
Larger end male copper for insertion into fitting x female copper



SIZE	BOX QTY	CODE	£ EACH
8 x 6mm	1	56134DW	11.38
15 x 8mm	1	56140DW	10.32
15 x 12mm	1	56142DW	10.32
22 x 15mm	1	56147DW	10.11
28 x 15mm	1	56150DW	18.24
28 x 22mm	1	56152DW	18.24
35 x 28mm	1	56156DW	21.16
42 x 28mm	1	56160DW	27.58
42 x 35mm	1	56161DW	27.24
54 x 28mm	1	56163DW	43.96
54 x 42mm	1	56165DW	43.96

8GHD Adaptor
Male copper for insertion into fitting x BSP taper male thread

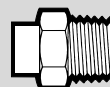

SIZE	BOX QTY	CODE	£ EACH
15mm x 1/2"	1	56220DW	30.94

11GHD Union coupling
Copper x copper

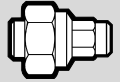

SIZE	BOX QTY	CODE	£ EACH
15mm	1	56252DW	37.62
22mm	1	56254DW	48.15
28mm	1	56255DW	68.81
42mm	1	56257DW	125.44

12GHD Elbow
Copper x copper



SIZE	BOX QTY	CODE	£ EACH
15mm	1	56292DW	24.22
22mm	1	56294DW	25.88
28mm	1	56295DW	38.42
42mm	1	56297DW	68.34
54mm	1	56298DW	118.84

24GHD Equal Tee
All ends for copper

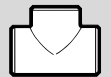

SIZE	BOX QTY	CODE	£ EACH
15mm	1	56339DW	27.80
22mm	1	56341DW	34.97
28mm	1	56342DW	46.09
35mm	1	56343DW	71.98
42mm	1	56344DW	91.64
54mm	1	56345DW	144.31

61GHD Stop End
For use on copper tube



SIZE	BOX QTY	CODE	£ EACH
15mm	1	56470DW	18.24

65GHD Bent Male Union Connector
Copper x BSP taper male thread
Round-nose to cone joint



SIZE	BOX QTY	CODE	£ EACH
15mm x 1/2"	1	56510DW	56.11
22mm x 3/4"	1	56512DW	75.61

68GHD Straight Union Adaptor
Copper x BSP union nut
Round-nose to cone joint



SIZE	BOX QTY	CODE	£ EACH
15mm x 3/4"	1	56539DW	16.71
22mm x 1"	1	56541DW	22.59

69GHD Straight Male Union Connector
Copper x BSP taper male thread
Round-nose to cone joint

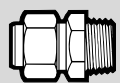

SIZE	BOX QTY	CODE	£ EACH
15mm x 1/2"	1	56561DW	29.51
22mm x 3/4"	1	56563DW	39.65
28mm x 1"	1	56564DW	88.38
35mm x 1 1/4"	1	56565DW	102.86
42mm x 1 1/2"	1	56566DW	123.57



GHD Fittings Degreased (contd)

70GHD

Male Hexagon Nipple

BSP union thread x BSP taper
male thread 60° cone

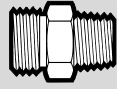

SIZE	BOX QTY	CODE	£ EACH
1" x 3/4"	1	56600DW	17.04

75GHD

Nut and Lining

Male copper lining for
insertion into fitting with
loose BSP union joint
Round-nose to cone joint

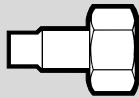

SIZE	BOX QTY	CODE	£ EACH
8mm x 3/8"	1	56638DW	18.96



Notes

1. General

In these conditions, reference to the Company shall mean Pegler Yorkshire. All quotations are made and all orders are accepted subject to these conditions. All other terms, conditions or warranties whatsoever are excluded from the contract or any variation thereof unless expressly accepted by the Company in writing. In the event of a conflict between these conditions and the specific terms and conditions of quotation then the latter shall prevail.

2. Electronic Trading

a) If the Company and Buyer agree that electronic trading between them shall be a basis for order processing and invoicing then the Standard Interchange Agreement (1st Edition March 1989) of the EDI Association shall be incorporated into the contract by reference subject to these conditions.

b) Electronic orders shall be valid if all the information agreed between the Buyer and the Company as being required is properly set out in the agreed format and the order is transmitted by the Buyer to the Company by reference to the correct identification code and is received by the Company when collecting its electronic mail from the relevant system.

c) Each valid electronic order will be deemed accepted by the Company unless the Company communicates rejection of the order to the Buyer by electronic or other means (including telephone) within 24 hours of receipt. Acceptance of an order shall constitute a contract for sale and purchase to which these conditions and the Standard Interchange Agreement shall prevail.

d) If the Company and the Buyer agree that invoicing may be done by electronic mail, then payment will be due 30 days after the date of electronic invoice unless agreed otherwise.

3. Delivery

Any date for delivery named by the Company is an estimate only and in no circumstances shall the failure of the Company to deliver on or before the named date either entitle the Buyer to rescind or terminate the contract or make the Company liable in any way for the consequences of any delay.

4. Export

Unless specifically stated otherwise in these conditions all trade terms not specifically covered by these conditions shall be interpreted in accordance with INCOTERMS current on the date of that order.

5. Warranty and Defective Goods

a) Save as otherwise provided by the other conditions of these Conditions, sections 12 to 15 of the Sale of Goods Act 1979 are to be implied into this contract.

b) The goods delivered under the Contract shall, where the Contract includes a specification, comply with the specification or, if there is no specification, shall be of normal industrial quality.

c) The Buyer does not rely on any statement or representations other than those which have been made in writing by the Company.

d) The Buyer must give the Company immediate written notice of any defect in the goods. Such goods shall be returned to the Company and if proved to have been defective at delivery as a result of faulty materials or workmanship, the Company shall at its option replace or repair such goods. Defects in quality or dimension in any delivery shall not be ground for cancellation of the remainder of the order.

e) Save for any liability for death or personal injury caused by the Company's negligence, the Company's liability in connection with defective goods shall be limited to the repair or supply of a replacement for the defective goods, and the Company shall not be liable for any other loss or damage including, but not limited to loss of profit, labour costs, damage to property, wasted expenditure or cost of mitigation.

6. Data and Technical Information

The information contained in the advertising sales and technical literature issued by the Company may be relied upon to be accurate in the exact circumstances in which it is expressed. Any illustrations, performance details, examples of illustrations and methods of assembly and all other technical data in such literature are based on experience and upon trials under test conditions and are provided for general guidance only.

7. Claims For Damage, Shortage or Loss

No claim for damage in transit or shortage of delivery can be accepted unless, a separate notice in writing is given to

the carrier concerned and to the Company within three days of receipt of the goods, followed by a complete claim in writing within five days of receipt of the goods. No claim for loss of goods in transit can be accepted unless a separate notice in writing is given to the carrier concerned and to the Company, and a complete claim in writing made within 21 days of the date of consignment. Where goods are accepted from the carrier concerned without being checked, the delivery book of the carrier must be signed "not examined". If a complaint is not made to the Company as herein provided, the products shall be deemed to be in all respects in accordance with the Contract, and the Buyer shall be bound to pay for the same accordingly.

8. Suspension of Deliveries

a) Deliveries may be wholly or partially suspended by the company in the event of:-

i. Stoppage, delay or interruption caused to the business of the Company as a result of strikes, lockouts, trade disputes, breakdown, accident or any cause whatsoever beyond the reasonable control of the Company.

ii. Any default by the Buyer in making payment of any amounts owed to the Company under this and any other contracts between them.

b) In the event of any hostilities (whether war is declared or not) in which Great Britain is involved, or in the event of national emergency, or if the Company's works should become either directly or indirectly engaged on Government orders as to prevent or delay work on other orders, the Company shall be entitled at any time, on notice to the Buyer, to make partial deliveries only or to determine the contract without prejudice in any case to rights accrued in respect of deliveries already made.

9. Determination of Contract

The Company shall have the right forthwith to determine this and/or any other Contract between the Buyer and the Company by written notice to the Buyer's last known address (without prejudice to any claim or right the Company might otherwise make or exercise) in any of the following events:-

a) If the Buyer shall make default in or commit a breach of any contract with the Company; or

b) If any distress or execution shall be levied upon the Buyer's property or assets; or

c) If the Buyer shall make or offer to make any arrangements or composition with creditors, or commit any act of bankruptcy or become insolvent; or

d) If any petition or receiving order in bankruptcy shall be presented or made against him; or

e) If the buyer shall be a limited Company and become subject of any resolution or petition for winding up or administration; or

f) If a receiver or manager of the Buyer's undertaking, property or assets or any part thereof shall be appointed.

10. Indemnity

The Buyer will indemnify the Company against all damages, penalties, costs and expenses to which the Company may become liable as a result of work done to the Buyer's instructions or which infringe any letters, patent or registered design or copyright or any other third party intellectual property rights.

11. Prices

The price payable for the goods shall unless otherwise agreed be the Company's list price current at the date of despatch. Such prices are inclusive of delivery to the Buyer's UK mainland delivery point but costs of delivery to any other destinations will be charged to the Buyer.

12. Risk and Title

a) Risk shall pass to the Buyer so that the Buyer is responsible for all loss, damage or deterioration to the goods:

i. If the Company delivers the goods by its own transport at the time when the goods or a relevant part thereof arrive at the place of delivery; or

ii. In all other circumstances at the time when the goods, or a relevant part thereof leave the premises of the Company whether or not the Company arranges transport and (without prejudice to clause 7) where the goods are delivered by carrier, any claims for loss or damage in transit must be made by the Buyer against the carrier in accordance with the carrier's conditions.

b) Title to the goods supplied under the contract shall only pass to the Buyer when payment in full for all goods supplied under this and all other contracts between the Company and the Buyer has been received by the Company. The Company reserves the immediate right to possession of and at any time may recover all goods in respect of which

title has not passed to the Buyer; the Company is hereby authorised by the Buyer to enter upon any premises where such goods are held by or on behalf of the Buyer and recover possession thereof.

c) Until title to goods has been passed to the Buyer pursuant to these conditions it shall possess the goods as a Bailee at will of the Company, and the Buyer shall not be entitled to sell or otherwise deal in goods in respect of which title has not passed to the Buyer. If the Buyer acts in breach of these conditions then without prejudice to any other rights of the Company the Buyer shall have a fiduciary duty to account to the Company for the proceeds of any sale save to the extent that any such proceeds exceed the amounts owed to the Company under this and all other contracts between the Company and the Buyer.

13. Cancellation

Cancellation will only be accepted by the Company on condition that all costs and expenses incurred by the Company up to the time of cancellation and all loss of profits and other loss or damage suffered by the Company as a result of such cancellation will be paid forthwith by the Buyer to the Company.

14. Payment of Accounts

a) Unless otherwise agreed by the Company in writing, payment shall be settled in full by the last working day of the month following the month in which the goods were despatched, or would have been despatched save for postponement otherwise than due to default on the part of the Company. The Company shall be entitled to submit its invoice on the same day as its delivery advice note or at any time thereafter, save that where delivery has been postponed at the request of or the default of the Buyer, then the Company may submit its invoice at any time after the goods are ready for delivery or would have been ready in the ordinary course but for the request or default as aforesaid.

b) The Company reserves the right to charge interest at a rate up to 5% above Lloyds Bank Base Lending Rate ruling at the time payment is due if payment is not made in accordance with the terms agreed at the time the order is accepted.

15. VAT

The prices quoted are exclusive of VAT which will, if applicable, be added to the invoice at the rate then current.

16. Consumer Protection Act

In circumstances where the Company supplies parts or goods to the Buyer for incorporation with, or use ancillary to, any composite goods to be produced, manufactured, processed or supplied by the Buyer then:

a) The Buyer shall forthwith on demand produce for inspection by the Company copies of all written instructions, information and warnings in relation to the said composite goods, provided nevertheless that such inspection or right to inspect shall not of itself constitute acceptance or approval on the part of the Company of such instructions, information, or warnings; and

b) The Buyer shall indemnify, reimburse and compensate the Company for all losses and damages (including costs, expenses and charges for legal actions in which the Company may be involved) that the Company may incur in the event that any claim or claims are made against the Company pursuant to the Act relating to the said composite goods of the Buyer or parts or goods supplied hereunder in circumstances in which the parts or goods supplied by the Company was either:

i. Not the defective part of the said composite goods; or

ii. Was only rendered the defective part or became defective goods by reason of actions or omission of the Buyer; or

iii. Was only rendered the defective part or became defective goods by reason of instructions or warnings given or omitted by the Buyer or other supplier of the said composite goods supplied hereunder.

c) For the purposes of this condition the word "defective" shall be interpreted in accordance with the definition contained in the Act and this condition shall mutatis mutandis apply in relation to equivalent legislation of other states as it applies in relation to the Act.

17. Law and Jurisdiction

This contract shall be governed and construed according to the Law of England and the parties hereby agree to submit to the exclusive jurisdiction of the English courts.



Pegler Yorkshire

Our brands:

terrier

HEATING SOLUTIONS

YORKSHIRE

SOLDER RING SOLUTIONS

Tectite

PUSH-FIT SOLUTIONS

XPress

PRESS-FIT SOLUTIONS

ENDEX

END FEED SOLUTIONS

KUTERLITE

COMPRESSION SOLUTIONS

PRESTEX

DOMESTIC VALVE SOLUTIONS

PEGLER

COMMERCIAL VALVE SOLUTIONS

meibes

RENEWABLE SOLUTIONS

PERFORMA

UTILITY TAP SOLUTIONS

**francis
pegler**

LUXURY TAP SOLUTIONS

UK sales

Free Phone: 0800 156 0010

Free Fax: 0808 156 1011

Email: uk.sales@peglyorkshire.co.uk

Export

Tel: +44 (0) 1302 855 656

Fax: +44 (0) 1302 730 513

Email: export@peglyorkshire.co.uk

Technical Help

Free Phone: 0800 156 0050

Free Fax: 0808 156 1012

Email: tech.help@peglyorkshire.co.uk

Brochure Hotline

Free Phone: 0800 156 0020

Free Fax: 0808 156 1011

Email: info@peglyorkshire.co.uk

www.peglyorkshire.co.uk

Pegler Yorkshire Group Limited

St. Catherine's Avenue, Doncaster,
South Yorkshire, DN4 8DF, England.

Tel: 0844 243 4400 Fax: 0844 243 9870

Registered in England Company No. 00401507

Registered Office: Haigh Park Road, Stourton, Leeds,
West Yorkshire, LS10 1RT, England.

All brand names and logo styles are registered trademarks.
Maintaining a policy of continual product development,
Pegler Yorkshire reserves the right to change specifications, design
and materials of products listed in this publication without prior notice.

LIT.REF: WEB ONLY